

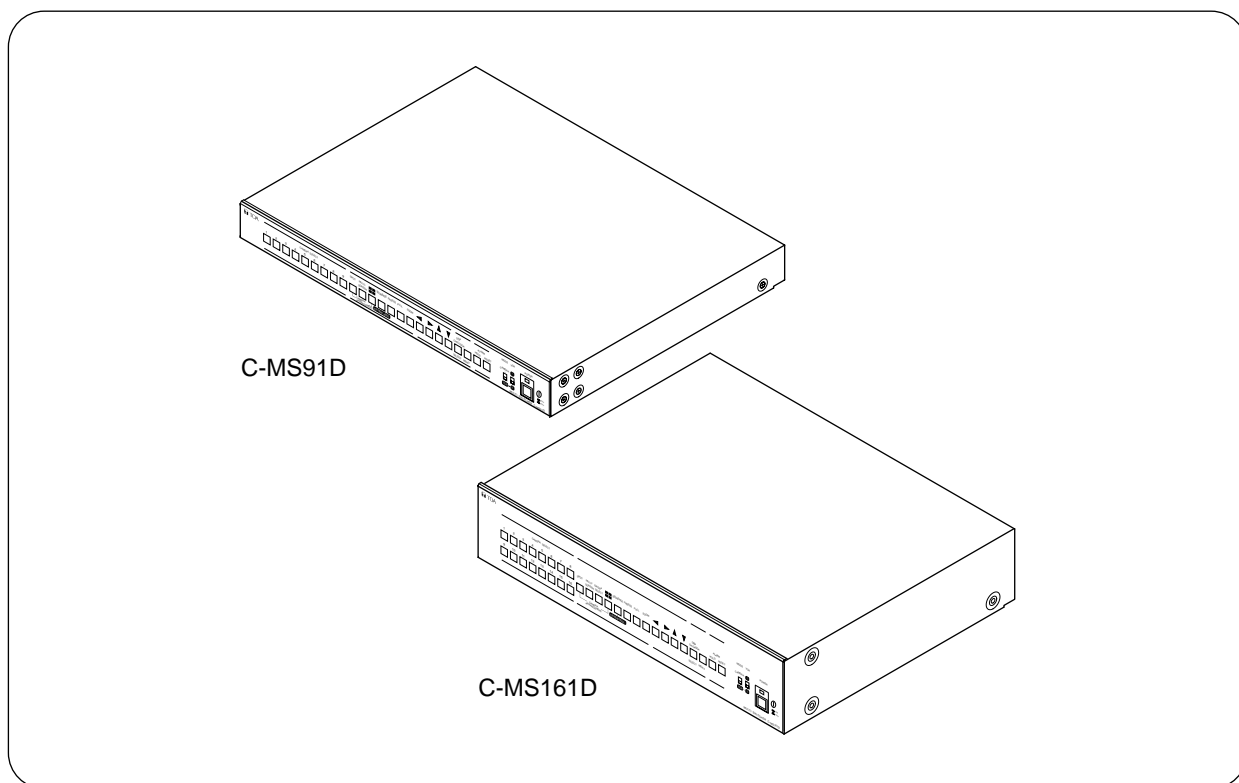

INSTRUCTION MANUAL

MULTI-SWITCHER

C-MS91D
C-MS161D



Please follow the instructions in this manual to obtain the optimum results from this unit.
We also recommend that you keep this manual handy for future reference.

TOA Corporation

TABLE OF CONTENTS

1. SAFETY PRECAUTIONS	6
<div style="border: 1px solid black; padding: 2px; display: inline-block;">The Outlines of the Multi-Switcher</div>	
2. GENERAL DESCRIPTION	8
3. FEATURES	8
4. HANDLING PRECAUTIONS	9
5. NOMENCLATURE AND FUNCTIONS	
Front Panel	10
Rear Panel	12
6. SCREEN CHARACTER DISPLAY	
6.1. Camera Image Output Screen Display	
6.1.1. Camera Title Display	14
6.1.2. Other Character Displays	15
6.2. Indications on VCR-Recorded Images	15
<div style="border: 1px solid black; padding: 2px; display: inline-block;">Settings</div>	
7. BEFORE PERFORMING SETTINGS	
7.1. Preparations Before Settings	16
7.2. Setting Keys	16
8. LIST OF SETTING ITEMS AND SETTING PROCEDURES	17
8.1. Basic Setting Procedures	17
8.2. English menu	18
8.3. Spanish menu	20
8.4. French menu	22
9. MENU SELECTION	
9.1. Initial Menu Screen	24
10. SETTINGS ON THE USER MENU SCREEN	
10.1. User Menu	24
10.2. Clock Settings	24
10.3. Summer time setting screen	25
10.4. Character Display (Monitor)	26
10.5. Alarm Information	26
10.6. Recording/Motion Pattern Selections	27
11. TOTAL MENU SCREEN SETTINGS	
11.1. Total Menu	28
11.2. Clock Settings	28
11.3. Title Settings	
11.3.1. Title Setting Camera Selection Screen	29
11.3.2. Title Setting Screen	29
11.4. Recording/Alarm Settings	32
11.5. Recording Settings	32
11.6. Alarm Settings	33
11.7. Alarm Input Terminal Settings	34

11.8. Option 1 Settings	35
11.9. Option 2 Settings	36
11.10. Buzzer/Character Display Settings	37
11.11. Other Settings	38
11.12. Remote Control Settings	39
11.13. Sequential Display Skip Settings	40
11.14. Monitor Output Sequential Display Skip Settings	40
11.15. Spot Output Sequential Display Skip Settings	40
11.16. Alarm Information	41
11.17. Recording Pattern Settings	
11.17.1. Recording Pattern Setting Screen	41
11.17.2. Individual Recording Pattern Setting Screen	42
11.18. Motion Detection Pattern Settings	
11.18.1. Motion Detection Pattern Setting Screen	42
11.18.2. Motion Detection Pattern Camera Setting Screen	42
11.18.3. Camera Motion Detection Pattern Setting Screen	43
11.18.4. Area Setting/Test Screen	44
12. CHANGING THE DISPLAY LANGUAGE	45
13. INITIALIZING SETTING CONTENTS	45
14. CHANGING CAMERA ARRANGEMENT ON MULTI-SCREEN DISPLAYS ..	46
15. VCR SETTINGS	
15.1. Displaying the VCR's Menu Screen	48
15.2. Setting the VCR's Display Characters	48
15.3. Setting the VCR's Alarm	48
15.4. Setting Alarm Recording for a VCR Not Currently in Operation	48
15.5. Others	48
OPERATIONS	
16. BASIC OPERATION MODE	
16.1. Keys to use in operations	49
16.2. Camera Mode and VCR Mode	
16.2.1. Camera/VCR Mode Selection	49
16.2.2. Operations for Screen Display Selection	49
16.3. Basic Multi-Switcher Operations	
16.3.1. Camera Image Viewing	50
16.3.2. VCR Recording	50
16.3.3. VCR Playback	50
17. CHANGING THE SCREEN DISPLAY MODE	
17.1. Viewing Camera Images on the Full Screen	
17.1.1. Full-Screen Display	51
17.1.2. Sequential Display (Camera mode only)	51
17.2. Viewing Camera Images on the 4-Segment Split Screen	
17.2.1. 4-Segment Split-Screen Displays	51
17.2.2. 4-Segment Split-Screen Sequential Displays (Camera Mode Only)	52
17.3. Viewing Camera Images in Multiple-Screen Displays	53
17.4. Viewing Camera Images in Zoom Displays (Electronic Zoom)	54
17.5. Displaying the Freeze Full Screen or Freeze Zoom Screen	55
17.6. Displaying the Freeze Screen During Multi-Screen Display	55

17.7. Spot Output Operations	
17.7.1. Spot Output Display Screen	56
17.7.2. Spot Output Switching	57
17.8. Camera Number and Date/Time Displays	58

FUNCTIONS

18. ALARM FUNCTIONS

18.1. Sensor Alarm	
18.1.1. Keys used in operations	59
18.1.2. Sensor Alarm Function	59
18.1.3. Sensor Alarm Activation	60
18.1.4. Sensor Alarm-Activated Operations	60
18.1.5. Sensor Alarm Reset	60
18.1.6. Sensor Alarm Interval	61
18.1.7. Alarm Hold	61
18.1.8. Simultaneous Multiple Alarm Operations	62
18.2. Motion Detection Alarm	
18.2.1. Motion Detection Function Settings	62
18.2.2. Motion Detection Alarm Reset	63
18.2.3. Motion Detection Alarm Interval	63
18.2.4. Alarm Operating Interval	63
18.3. VCR Playback Alarm	
18.3.1. When the VCR Playback Alarm is activated	64
18.3.2. VCR Playback Alarm Reset	64
18.4. Video Loss Alarm	
18.4.1. If the Video Loss alarm is triggered	65
18.4.2. To reset the Video Loss alarm	65
18.5. Alarm Information	
18.5.1. To display the stored date, time and camera number	65
18.5.2. Alarm Information Screen Example	65
18.6. Alarm Input/Output Terminals	66

19. REMOTE CONTROL FUNCTION

19.1. About the Remote Control Function	67
19.2. Remote Controller Usage	67
19.3. Remote Input/Output Terminal	
19.3.1. Remote Output Terminal	70
19.3.2. Remote Input Terminal	71
19.3.3. Recording Pattern Selection Input Terminal	72
19.3.4. Motion Detection Pattern Selection Input Terminal	72
19.3.5. Sequence Switching I/O Terminal	72

20. MOTION DETECTION

20.1. About the Motion Detection Function	73
20.2. Basic Motion Detection Operations	
20.2.1. Detection Function and Setting/Operation	73
20.2.2. Switcher Operation in Response to Motion Detection	75
20.3. Motion Detection Pattern Function	76

21. OTHER FUNCTIONS

21.1. When Using 2 VCRs (Continuous Recording Function)	76
---	----

21.2. Recording Pattern Function	77
21.3. Auto-Recognition During Time-Lapse Recording	77
21.4. Sequential Switching Timing Adjustment	78
21.5. Monitor Indication Adjustment	78
21.6. Key Locking	79
21.7. Screen Display When Power Is Switched On	79

CONNECTIONS

22. CONNECTIONS

22.1. Preparation Before Making Connections	80
22.2. Camera Connections	
22.2.1. When using Single-cable cameras	80
22.2.2. When using 24V AC or AC mains cameras	80
22.3. Monitor TV Connections	80
22.4. VCR Connections	80
22.5. Dedicated Remote Controller Terminal Connections	
22.5.1. Connection Cables	81
22.5.2. Connected Equipment Termination Switch Settings	81
22.6. RS-232C Terminal Connections	81

23. CONNECTION EXAMPLES

23.1. Basic Connections	
23.1.1. C-MS161D Multi-Switcher	82
23.1.2. C-MS91D Multi-Switcher	83
23.2. Connections in Systems Using Two VCRs	
23.2.1. C-MS161D Multi-Switcher	84
23.2.2. C-MS91D Multi-Switcher	85
23.3. Connections Using the Dedicated Remote Controller Line	
23.3.1. Connection to the C-RM100 Remote Controller	86
23.3.2. Connection to the C-RM500 Remote Controller	87

SUPPLEMENT

24. RACK MOUNTING	88
-------------------------	----

WHEN NEEDING A HELP

25. TROUBLESHOOTING	89
26. SPECIFICATIONS	90
26.1. Accessories	94
26.2. Optional Equipment	94

1. SAFETY PRECAUTIONS

- Be sure to read the instructions in this manual section carefully before use.
- Make sure to observe the instructions in this section as the conventions of safety symbols and messages regarded as very important are included.
- Please keep this instruction manual handy for future reference.

Safety Symbol and Message Conventions

Safety symbols and messages described below are used in this manual to prevent bodily injury and property damage which could result from mishandling. Before operating your equipment, read this manual first so you are thoroughly aware of the potential safety hazards as well as understand the safety symbols and messages.



WARNING

Indicates a potentially hazardous situation which could result in death or serious personal injury if ignored or mishandled.

When Installing the Switcher

- This is a class A product. In a domestic environment this product may cause radio interference in which case the user may be required to take adequate measures.
- Do not expose the unit to rain or an environment where it may be splashed by water or other liquids, as doing so may result in fire or electric shock.
- Use the unit only with the voltage specified on the unit. Using a voltage higher than that which is specified may result in fire or electric shock.
- Avoid installing the unit in unstable locations, such as on a rickety table or a slanted surface. Doing so may result in the unit falling down and causing personal injury.

When Using the Switcher

- Should the following irregularities be found during use, immediately switch off the power, disconnect the power supply plug from the AC outlet and contact your nearest TOA dealer. Do not attempt to further operate the unit to avoid fire or electric shock.
 - If you detect smoke or a strange smell coming from the unit.
 - If water or other foreign objects get into the unit.
 - If the unit falls, or the unit case breaks.
 - If the power supply cord is damaged (exposure of the core, disconnection, etc.)
 - If it malfunctions (no camera image is displayed).
- Do not open the unit's case for modification. Since there are high voltage components inside the unit, opening or modifying the case may result in fire or electric shock. Refer all servicing to your TOA dealer.
- Do not place cups, bowls or other containers of liquid or small metal objects on top of the unit. If they accidentally spill or get into the unit, this may cause fire or electric shock.
- Do not insert such foreign objects as metal pieces nor allow flammable objects to get into the unit to avoid fire or electric shock.
- Do not touch a power supply plug or coaxial cable during thunder and lightning, as this may result in fire or electric shock.

CAUTION

Indicates a potentially hazardous situation which could result in moderate or minor personal injury, and/or property damage if ignored or mishandled.

When Installing the Switcher

- Never plug in nor remove the power supply plug with wet hands, as doing so may cause electric shock.
- When unplugging the power supply cord, be sure to get hold of its plug. Never pull on the cord itself. Operating the unit with a damaged power supply cord may cause a fire or electric shock.
- Be sure to remove the power supply cord from the wall outlet when moving the unit. Moving the unit with the cord connected to the outlet may cause damage to the cord, causing fire or electric shock.
- Avoid installing the unit in humid or dusty locations, in locations exposed to the direct sunlight, or in locations generating sooty smoke or steam as doing otherwise may result in fire or electric shock.

When Using the Switcher

- Do not place heavy objects on the unit. Such object may fall or the unit may topple over, possibly resulting in personal injury.
- Clean the unit periodically. If dust is allowed to accumulate in the unit over a long period of time, a fire may result. Contact your TOA dealer as to the cleaning.
- Clean the power supply plug and wall outlet periodically. If dust accumulates on the power supply plug or wall outlet, a fire may result. Also, fully insert the plug into the outlet.
- Switch off the power and unplug the power supply plug from the wall outlet for safety purposes when leaving the unit unused for a long period of time. Failure to observe this instruction may cause fire or electric shock.

Underwriters Laboratories Inc. (UL) has not tested the performance or reliability of the security aspects of this product. UL has only tested for fire, shock or casualties as outlined in UL's Standard(s) for Safety. UL Certification does not cover the performance or reliability of the security hardware and security operating software. UL MAKES NO REPRESENTATIONS, WARRANTIES OR CERTIFICATIONS WHATSOEVER REGARDING THE PERFORMANCE OR RELIABILITY OF ANY SECURITY RELATED FUNCTIONS OF THIS PRODUCT.

2. GENERAL DESCRIPTION

The TOA Multi-Switcher permits sequential viewing of up to 9 connected cameras (C-MS91D) or up to 16 cameras (C-MS161D) on a full monitor screen, as well as simultaneous viewing of individual camera images in multi-screen displays (such as 4- and 9-segment split screens) to ensure that nothing is missed. It features a frame recording function that records all connected cameras on a single VCR in sequential order while viewing camera images in full-screen, multi-screen or zoom-screen modes. VCR-recorded images can also be viewed in any of these formats. Additionally, when a change, or movement, is detected in any of the camera images, a motion detection function can be set to record those cameras on a priority basis, remotely enabling an alarm in the connected VCR or other external equipment, thus allowing camera images to be more efficiently checked.

3. FEATURES

Duplex Operation

The Multi-Switcher's duplex operation permits real-time surveillance of connected camera images in multi-screen (4-, 9-, 10- or 16-segment split-screen) displays while being frame-recorded.

High Picture Quality

The Multi-Switcher not only reduces flickering generated during split-screen display, but also realizes a high-quality zoom display.

A Wealth of Display Functions

During real-time camera surveillance and VCR recording playback, camera images can be displayed on 4-, 9- or 16-segment (C-MS161D only) split screens or 2x zoom screens. Also, during real-time camera surveillance, connected camera images can be viewed on a 10-segment split screen, or in sequential order on either the full screen or a 4-segment split screen.

Non-Stop Recording Misses Nothing

The Multi-Switcher features 2 sets of VCR connection terminals to permit continuous recording using 2 VCRs. This ensures no recording is missed when changing or rewinding tapes. In addition, recording can still be performed uninterrupted with one VCR even while the other is being used for playback.

Motion Detection

When a change or movement is detected in a camera image, the affected camera is preferentially recorded by increasing the number of recording frames and remotely alarm-triggering the connected VCR or other external equipment, thus allowing camera images to be more efficiently checked.

Key Locking

Front panel operation keys can be locked to prevent accidental changes of key settings.

Uninterrupted Time-Lapse Video Recording ("Auto-Recognition" Function)

The time-lapse VCR continues to record even if the switcher control signal cables are broken or faulty contact occurs during time-lapse video recording.

Changeable Multi-Screen Display Positions

Camera display positions on multi-screen displays in Camera mode can be changed as desired.

Various System Configurations Possible

The additional use of the Multi-Switcher's optional dedicated remote controller and optional single-channel controller creates an integrated Combination Camera/Multi-Switcher system. The Multi-Switcher can be operated from remote locations by using the dedicated remote controller.

The RS-232C Interface

The Multi-Switcher's standard RS-232C computer connector permits easy remote operation by way of a computer or other external equipment.

4. HANDLING PRECAUTIONS

About general maintenance parts

The rechargeable lithium battery powering the Multi-Switcher's built-in clock is a replaceable general maintenance part. Its life expectancy is approximately 10 years (provided it is used at a room temperature of approximately 25°C), although this can vary depending on the environment and conditions of battery use. Note that the replacement of such maintenance parts is not covered by warranty. Please contact your TOA dealer when replacing the battery.

Other precautions

- Use the Multi-Switcher in locations where the temperature ranges from 0°C to +40°C, and the humidity is less than 90%.
- To clean, wipe with a dry cloth. When the Multi-Switcher is very dirty, use a cloth damped in a neutral detergent. Never use benzene, thinner or chemically-treated towel to avoid damage to the Multi-Switcher's finish. Be sure to switch off the power before cleaning.
- Keep the front, rear and the sides of the Multi-Switcher at least 10 cm away from the wall surface.

NTSC version complies with Part 15 of the FCC Rules.

Note

This equipment has been tested and found to comply with the limits for a Class A digital device, pursuant to Part 15 of the FCC Rules. These limits are designed to provide reasonable protection against harmful interference when the equipment is operated in a commercial environment. This equipment generates, uses, and can radiate radio frequency energy and, if not installed and used in accordance with the instruction manual, may cause harmful interference to radio communications. Operation of this equipment in a residential area is likely to cause harmful interference in which case the user will be required to correct the interference at his own expense.

Modifications

Any modifications made to this device that are not approved by TOA Corporation may void the authority granted to the user by the FCC to operate this equipment.

5. NOMENCLATURE AND FUNCTIONS

[Front Panel]

C-MS161D

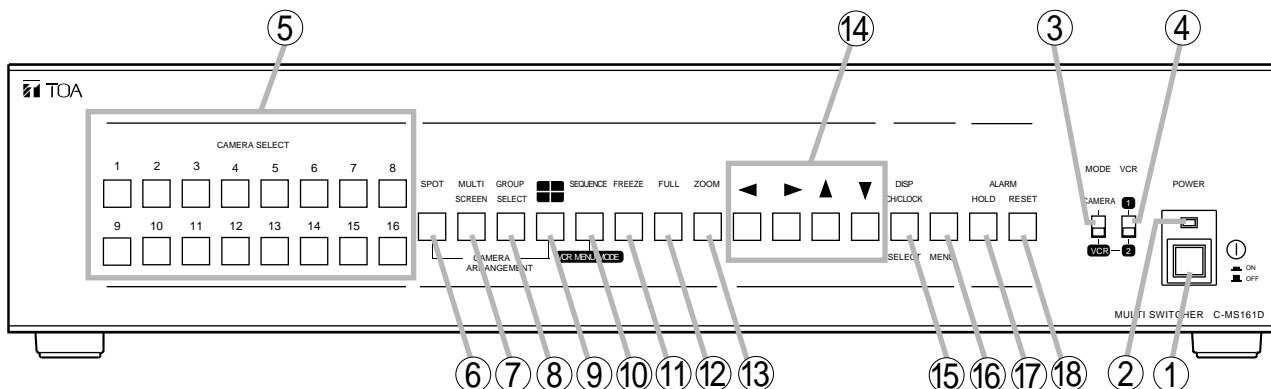

C-MS91D

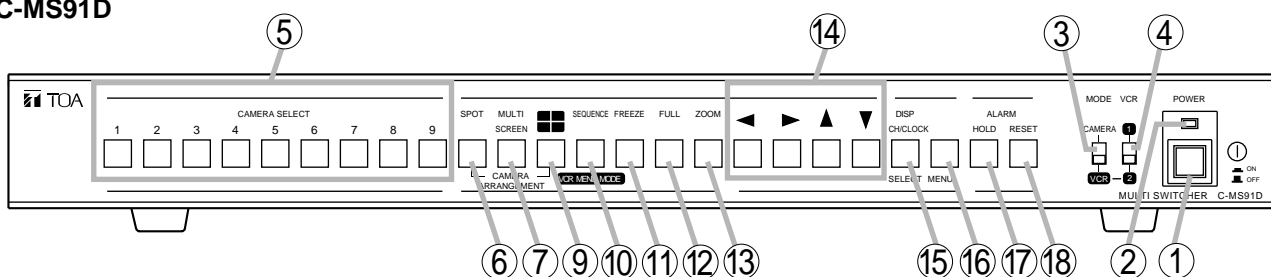

(1) Power Switch [①]

Power is switched on and off with each depression of this switch.

(2) Power Indicator

Lights when the power switch is turned on.

(3) Camera/VCR Mode Selector Switch

Selects either real-time camera images (Camera mode) or VCR playback images (VCR mode) for monitor display.

• Camera mode

Connected camera images are displayed in real time on the monitor.

• VCR mode

Camera images previously recorded on a connected VCR are displayed on the monitor.

(4) VCR Selector Switch (Valid only while in VCR mode)

Selects either VCR 1 or VCR 2 when playing back the VCRs connected to their corresponding terminals. Because both VCRs can be used for recording, it is not necessary to designate either VCR when recording.

Note

It is impossible to simultaneously use VCR1 and VCR2.

(5) Camera Selector Keys

• During operation

The key for the camera image currently on screen is illuminated. Keys for cameras in freeze-frame mode or alarm mode flash. The key for a camera in sensor-alarm or motion detector alarm mode also flashes, even when the corresponding camera is not currently displayed on the monitor.

• During setting

Use to enter setting values. (C-MS91D: 1 - 9; C-MS161D: 1 - 10)

• Full-screen camera display selection

Select the camera to be displayed on the full screen. The key for the selected camera lights.

• Freeze-frame camera display selection

To display, press the Freeze key during multi-screen (4-, 9-, 10-* and 16-segment split-screen) display, and select the camera number to be displayed on the freeze screen while the Freeze key is flashing.

(6) Spot Selector Key

Enabled only when Monitor Output 2 is designated as a spot output in the menu settings. (For more information, refer to p. 38; Monitor Output 2 in Other Settings.)

This key is used to select the camera image to be provided from Monitor Output 2 (Spot Output). To select, press the Spot selector key (flashes when enabled), followed by the desired Camera selector key or Sequence key.

Note

On the C-MS91D, this key is used to enter the number 0 during settings.

(7) Multi-Screen Key

Displays camera images in multi-screen monitor displays. The screen mode cycles through 9-, 10-* and 16-segment split-screen displays with each depression of the key. This key remains lit during multi-screen display.

Note

The 16-segment display mode is not available to the C-MS91D.

(8) Group Selector Key (C-MS161D only)

Selects the camera group to be displayed on the 4-, 9- or 10-segment* split screen. Only the displayed camera images change, without changing the split screen mode.

(9) 4-Segment Split Display Key []

Displays camera images on the 4-segment split screen. Displayed camera groups (Groups 1 - 4; Group 4 only available to the C-MS161D) cycle with each depression of the key. This key remains lit during 4-segment split-screen display.

(10) Sequence & VCR Menu mode Key

Operation of this key differs depending on the setting of the Camera/VCR Mode Selector Key.

[Camera Mode]

- If viewing camera images on the full screen...
Connected camera images are displayed in sequential order on the full screen. Viewing intervals are set on the menu screen. (Refer to p. 35; Sequence Dwell Time in Option 1 Setting Screen.)
- If viewing camera images on the multi-screen (4-, 9-, 10- and 16-segment split-screen displays)...
Connected camera images are displayed in sequential order on the 4-segment split-screen display. Viewing intervals are set on the menu screen. (Refer to p. 35; Sequence Dwell Time in Option 1 Setting Screen.)

[VCR Mode]

Images recorded on the connected VCR are played back and directly displayed on the monitor screen. This key is used to fast-forward or rewind the tape, or perform VCR settings.

(11) Freeze Key

- If viewing on full-screen or zoom-screen displays...
Pressing this key causes the screen image to stand still (freeze). Press this key again to reset the freeze screen. The key flashes while the screen is in freeze-frame mode.
- If viewing on multi-screen (4-, 9-, 10-* or 16-segment split-screen) displays...
To freeze the screen, press the Freeze key during multi-screen display (the key flashes), then select the camera to freeze with the Camera selector key. Pressing the Freeze key again resets the freeze-frame mode.





Note

The Freeze key does not work during sequential display (full screen or 4-segment split-screen displays).

(12) Full Screen Key

Displays camera images on the full screen. This key is also used to reset zoomed displays back to the ordinary full screen display. The key remains lit during full screen display.

(13) Zoom Key

Displays camera images on the 2x zoom (electronic zoom) screen. Use the Cursor control keys (   ) to move the zoom position. The Zoom key remains lit during zoom-screen display.

(14) Cursor Control Keys [   ]

Move the cursor on the menu screen. Also used to move the zoom position during zoom-screen display.

(15) Channel/Clock Display & Selector Key

- Operation
Displays the camera number and current date/time on the monitor. (Camera number is only displayed when in Camera mode.) Pressing the key changes the displayed camera title to its assigned camera number. Current date/time is displayed in the center of the screen when the key is pressed again. Camera number and date/time displays automatically revert to the original display in approximately 10 seconds.
- Setting
Selects the setting item in the menu screen.

(16) Menu Key

Hold this key down for 1 second or more to display the initial menu screen on the monitor. (Refer to p. 17; Basic Setting Procedures.)

(17) Alarm Hold Key

Alarm is put on hold when this key is pressed, and is reset when pressed again. In Alarm Hold mode, the monitor screen does not change even if the sensor-triggered alarm or motion detection alarm is enabled. However, the alarm-triggered camera image is recorded on a VCR. (Refer to p. 61; Alarm Hold.)

(18) Alarm Reset Key

Provides different operations depending on the Camera/VCR Mode selector switch setting.

[Camera Mode]

Flashes when the sensor-triggered alarm, motion detection alarm or video loss alarm is enabled. The light for this key changes from flashing to steady ON when the alarm interval (set on the menu screen) expires, indicating that the alarm has been enabled. Pressing this key during alarm operation resets the alarm. (Refer to p. 59; Sensor Alarm, p. 62; Motion Detection Alarm, and p. 65; Video Loss Alarm.)

[VCR Mode]

Flashes if an alarm-recorded portion of video is detected during VCR playback. (Buzzer also simultaneously sounds.) Pressing this key during alarm VCR playback stops the buzzer. (The flashing key is not reset.) (Refer to p. 64; VCR playback Alarm.)

* The 10-segment split-screen display can only be used in Camera mode.

[Rear Panel]

C-MS161D

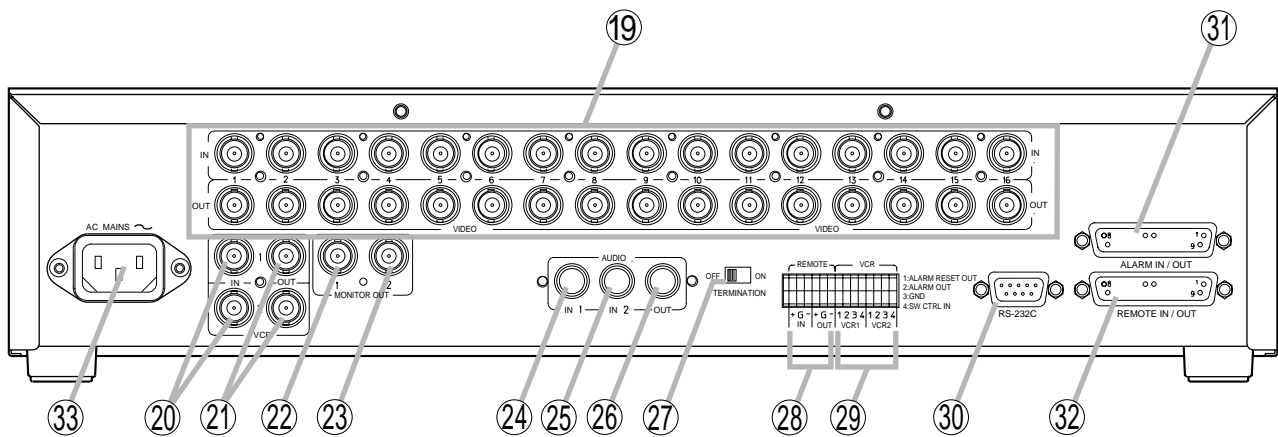

C-MS91D

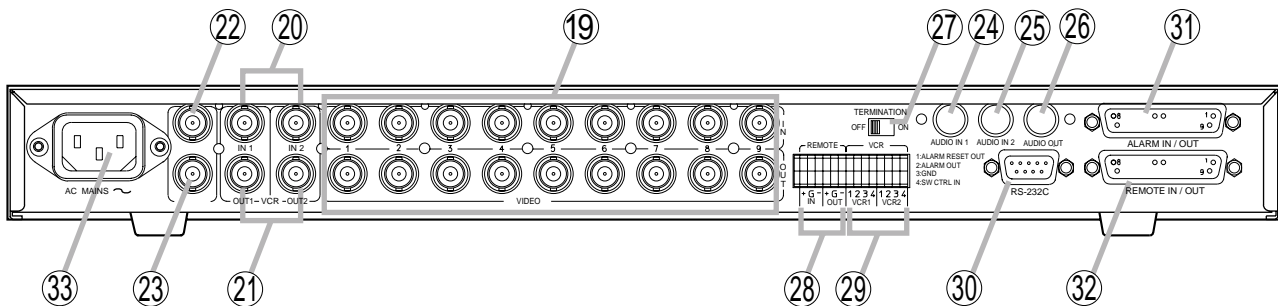

(19) Camera Input and Output Terminals

- Video input terminals
Connect to camera or camera drive unit video output terminals for video signal input. BNC connections automatically terminate the input at 75Ω.
- Video output terminals
Connecting a BNC connector automatically converts the output to a high-impedance type, permitting bridge connection.

(20) VCR Input Terminals 1 and 2

Connect to the VCR's video output terminals for video signal input.

(21) VCR Output Terminals 1 and 2

Connect to the VCR's video input terminals for video signal output.

(22) Monitor Output Terminal 1

Connect to the monitor's video input terminal for video signal output.

(23) Monitor Output Terminal 2 (Spot Output Terminal)

Connect to the monitor's video input terminal for video signal output. This terminal is factory-preset as the Spot output, however it can be changed in the menu screen settings to the same output as Monitor Output 1. (Refer to p. 38; Monitor Output 2 in Other Settings Screen.)

(24) Audio Input Terminal 1 (for VCR 1)

Connect to the VCR's audio output terminal for audio signal input.

(25) Audio Input Terminal 2 (for VCR 2)

Connect to the VCR's audio output terminal for audio signal input.

(26) Audio Output Terminal

Connect to the monitor's audio input terminal for audio signal output.

(27) Remote Control Termination Switch

Used when connecting dedicated remote controller lines. (Refer to p. 81; Dedicated Remote Controller Terminal Connections.)

(28) Dedicated Remote Controller Terminals

Used for connection of C-RM100 and C-RM500 Remote Controllers (optional), permitting the Multi-Switcher to be remotely operation. (Refer to p. 81; Dedicated Remote Controller Terminal Connections, and p. 67; Remote Controller Usage.)

(29) VCR Control Terminals

- Alarm Reset Output Terminal
Connects to the alarm reset input of time-lapse VCRs that require an alarm reset signal.
- Alarm Output Terminal
Connects to a time-lapse VCR's alarm input terminal.
- Ground Terminal
Connects to a time-lapse VCR's ground terminal.
- Switcher Control Input Terminal
Connects to a time-lapse VCR's switcher control output terminal.

(30) RS-232C Terminal (Non LPS)

Connects to the computer's RS-232C connector when controlling the Multi-Switcher from the computer. (Refer to p. 81; RS-232C Terminal Connections.)

(31) Alarm Input/Output Terminal

Used when externally activating the sensor alarm by means of a sensor, or when using the motion detection function as an alarm. (Refer to p. 66; Alarm Input/Output Terminal.)

(32) Remote Input/Output Terminal

Used when remotely operating the Multi-Switcher from external equipment. (Refer to p. 70; Remote Input/Output Terminal.)

(33) AC Inlet

Connects to the supplied power cord.

6. SCREEN CHARACTER DISPLAY

6.1. Camera Image Output Screen Display

6.1.1 Camera Title Display

Title character display positions cannot be changed.

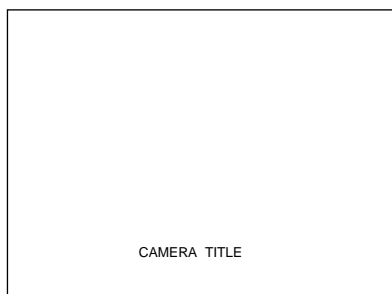

Full screen display

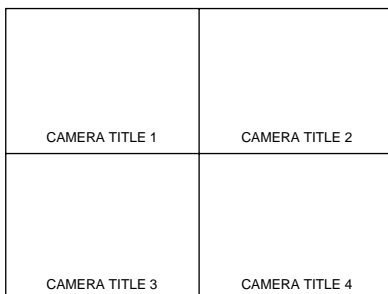

4-segment split-screen display

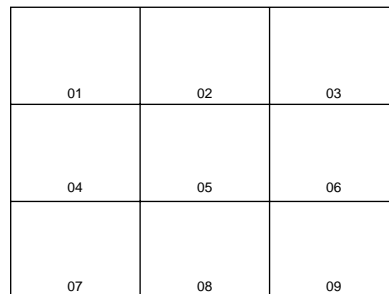

9-segment split-screen display

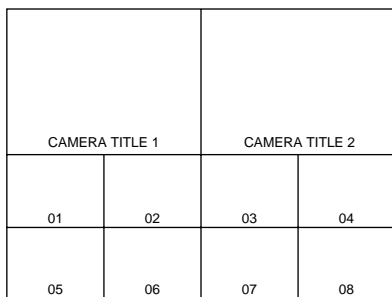

10-segment split-screen display

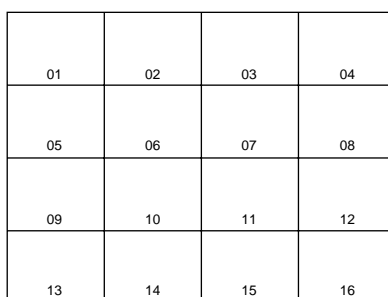

16-segment split-screen display
(C-MS161D only)

- Camera titles set on the menu screen are displayed at the lower part of the full screen, 4-segment split screen, and upper two screens of the 10-segment split screen. (Refer to p. 29; Title Settings.)
- When Monitor Output 2 is set as the Spot output, only the camera title is displayed on the full screen display or full sequential screen. (Refer to p. 38; Monitor Output 2 on the Other Settings screen.)
- The camera title cannot be displayed on the lower screens of 9-segment and 10-segment split screen, and on the 16-segment split screen. Camera numbers, however, can be set for display. Camera numbers correspond to the video input number on the rear panel. (Refer to p. 37; Title (Monitor) on the Buzzer/Character Display Setting Screen.)
- When the display is switched to the freeze-frame screen, the camera title indication changes to the flashing "FREEZE" indication, and the camera number to the flashing "F" indication.
- Switching the screen to multi-screen display while in Sensor alarm or Motion detection alarm modes changes the camera title indication of the sensor-triggered camera to the flashing "ALARM" indication, and the camera number indication to the flashing "AL" indication.
- If the Video Loss alarm is triggered during a multi-screen display, the camera title indication changes to "VIDEO LOSS," while the camera number indication changes to "VL."
Pressing the Alarm reset key resets the Video loss alarm, turning off the "VIDEO LOSS" and "AL" indications.
- Both camera titles and camera numbers can be displayed or hidden. (Refer to p. 37; Title (Monitor) on the Buzzer/Character Display Setting Screen.)
- It is impossible to separately display and hide the following indications:
 - (1) "FREEZE" and "F" indications in freeze-frame mode.
 - (2) "ALARM" and "AL" indications displayed when sensor-alarm or motion detection alarm is triggered.
 - (3) "VIDEO LOSS" and "VL" indications displayed when video loss alarm is triggered.

6.1.2. Other Character Displays

The following data can be displayed by settings. (Refer to p. 37; Buzzer/Character Display Settings screen.) However, character display positions cannot be changed.

(1) Date and time

Displays the date and time (in 24-hour format).

(2) Video Loss (VL01 through VL16 indications)

Displays the number corresponding to the alarmed camera when the Video Loss alarm is activated.

Pressing the Alarm reset key resets the Video Loss alarm and turns off the alarm indication.

Note: The indication is not displayed on the Spot output.

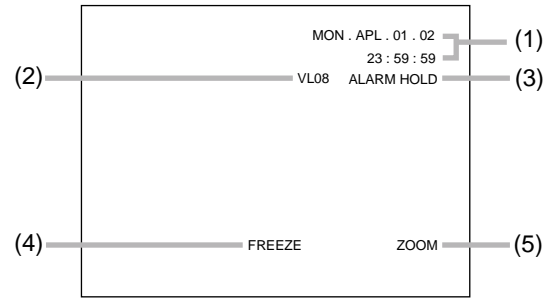

(3) Alarm

- Alarm indication

Flashes the "ALARM" indication when the Sensor alarm or Motion Detection alarm is activated. Pressing the Alarm reset key resets the alarm, and turns off the alarm indication. (Refer to p. 59; Sensor Alarm and p. 62; Motion Detection Alarm.)

Note: The alarm indication is not displayed on the Spot output.

- Alarm hold indication

Flashes the "ALARM HOLD" indication if an alarm signal is received when the Sensor or Motion Detection alarm is placed on hold by way of the Alarm Hold key. (Refer to p. 61; Alarm Hold.)

Note: The alarm hold indication is not displayed on the Spot output.

(4) Freeze

When the screen is switched to the freeze-frame display, the camera title indication changes to the flashing "FREEZE" indication. Resetting the freeze display turns off the indication.

(5) Zoom

The "ZOOM" indication is displayed during zoom operation. The indication disappears if the zoom display is reset.

6.2. Indications on VCR-Recorded Images

The following information can be displayed on images recorded on the VCR. They can be individually displayed or hidden, except the Auto recognition function. (Refer to p. 37; Buzzer/Character Display Setting Screen.) Character display positions, however, cannot be changed.

(1) Auto recognition

Displayed when a switcher control signal is not received from a connected time-lapse VCR due to cable breakage during time-lapse video recording. (Refer to p. 77; Auto Recognition During Time-Lapse Video Recording.)

(2) Date and time

Displays the current date and time.

(3) Camera title

Displays the camera title.

(4) Video loss ("VL01" – "VL16")

Displays the alarmed camera number when Video Loss alarm occurs. A suffix "A" is displayed for the corresponding camera number (for example, VL01A) if the Video Loss-alarmed camera receives an alarm signal.

(5) Alarm

The "ALARM" indication is displayed when the Sensor alarm or Motion Detection alarm is activated.

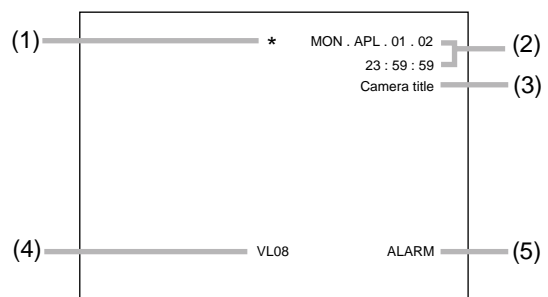

7. BEFORE PERFORMING SETTINGS

7.1. Preparations Before Settings

- Connect cameras, VCRs, and all other equipment necessary for the system.
- Switch ON the power of the Multi-Switcher and all connected equipment, such as cameras, VCRs, and monitors.

Note

Camera images cannot be recorded on a VCR while settings are being performed on the menu screen. The Sensor alarm and Motion Detection alarm are not operated, either. However, the Motion Detection function is internally kept in operation during setting, and the unit may be put in alarm mode after exiting the menu screen.

7.2. Setting Keys

The following keys are used for menu screen settings.

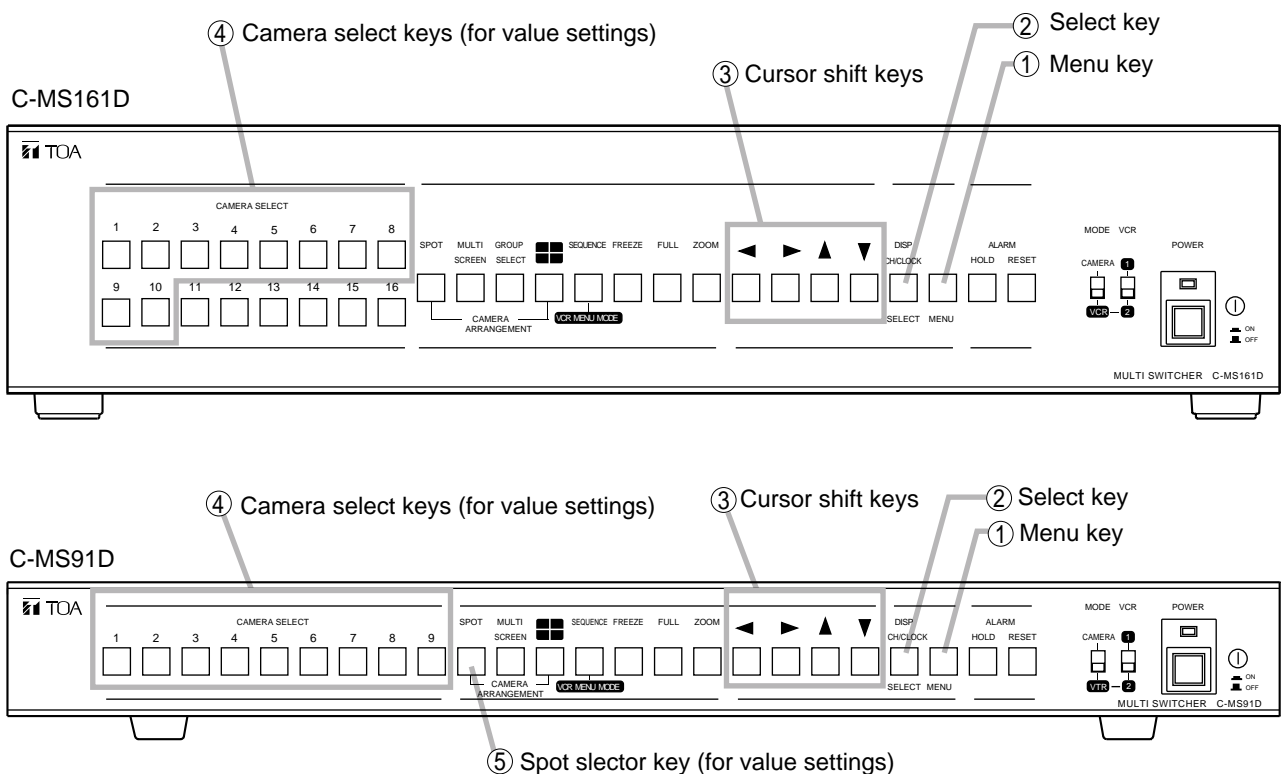

(1) Menu Key

- Holding down the Menu key for one second or more causes the initial menu screen to be displayed on the monitor.
- Pressing the Menu key returns the menu screen and setting screen to the previous screen.
- Press the Menu key to display the normal camera display screen after exiting the initial menu screen.

(2) Selector Key

Used to select setting item contents.

(3) Cursor Shift Keys [◀▶▲▼]

Used to move the cursor.

(4) Camera Selector Keys (for value settings)

- Used to enter values.
- Use Camera Selector Keys 1 - 9 to enter 1 - 9.
- Use Camera Selector Key 10 to enter 0 (C-MS161D only).

(5) Spot Selector Key (for value settings)

Used to enter 0 (C-MS91D only).

8. LIST OF SETTING ITEMS AND SETTING PROCEDURES

8.1. Basic Setting Procedures

The [] section in the figure represents the cursor. On the screen, the character indication flashes.

Note

If no operations are performed for 5 minutes on the initial menu or setting screens, the screen automatically reverts to its normal state (camera display screen).

1. Enter the initial menu screen.

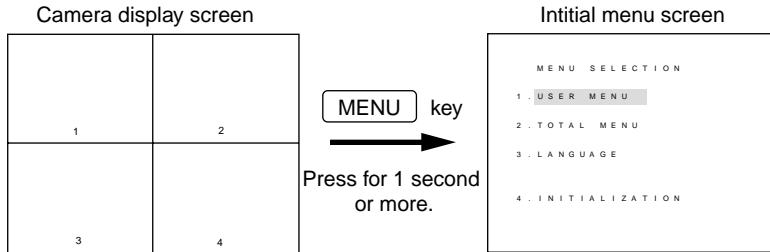

2. Enter the menu screen.

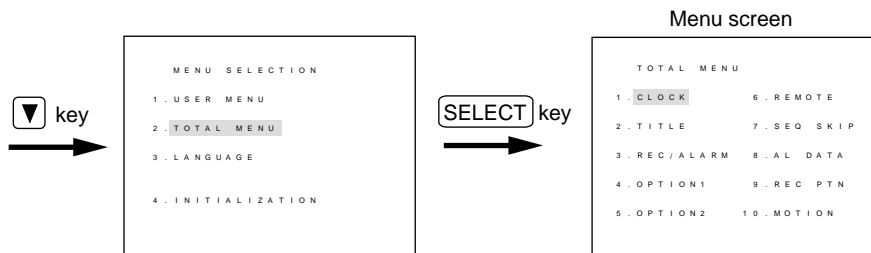

3. Select the setting contents.

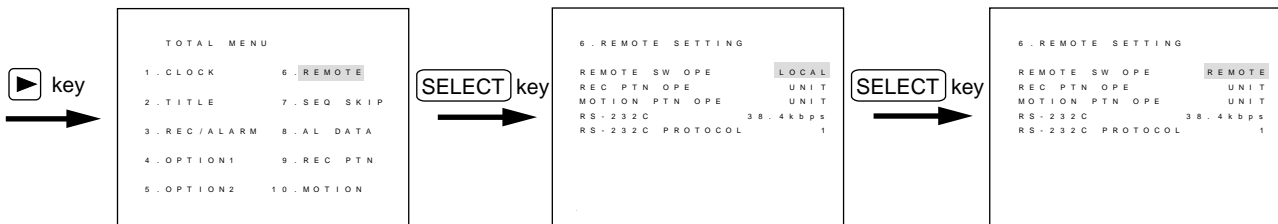

4. Confirm the set contents and return to the camera display screen.

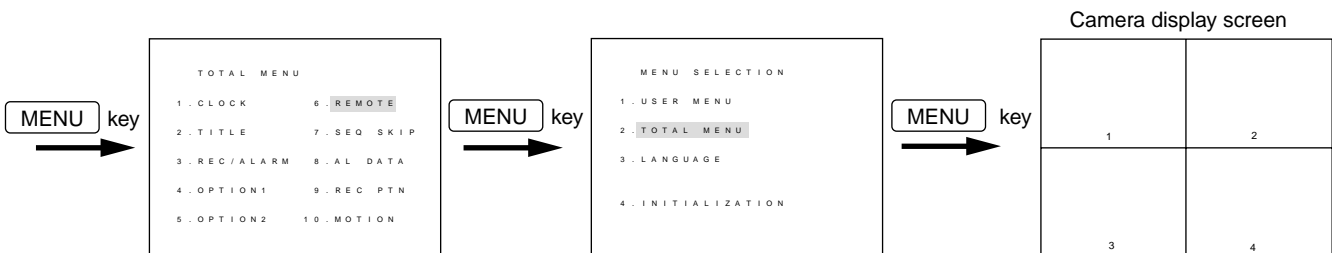

8.2. English menu

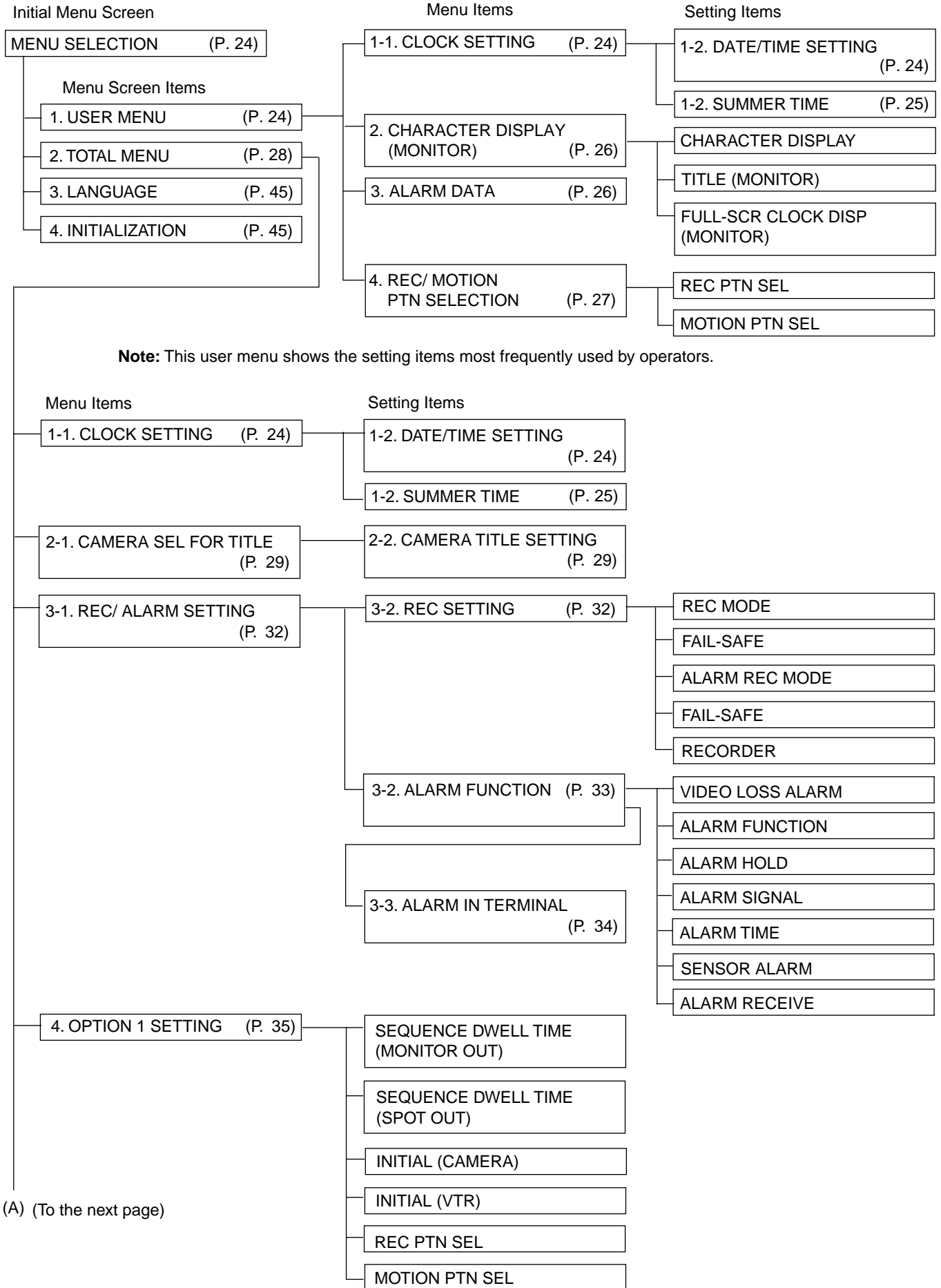

Note: All setting items are displayed on the total menu. Set all the items on this screen when installing the unit.

(A)

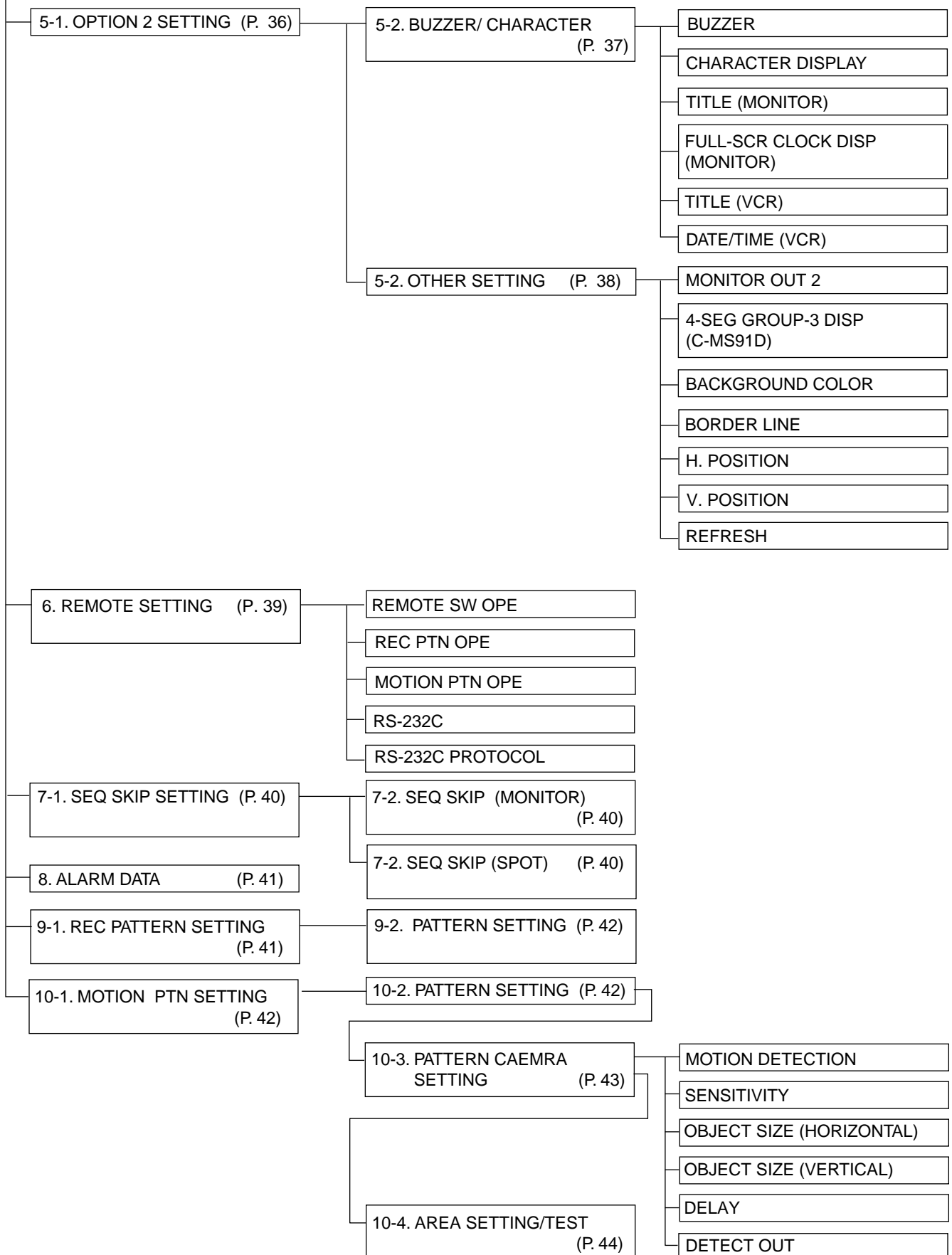

8.3. Spanish menu

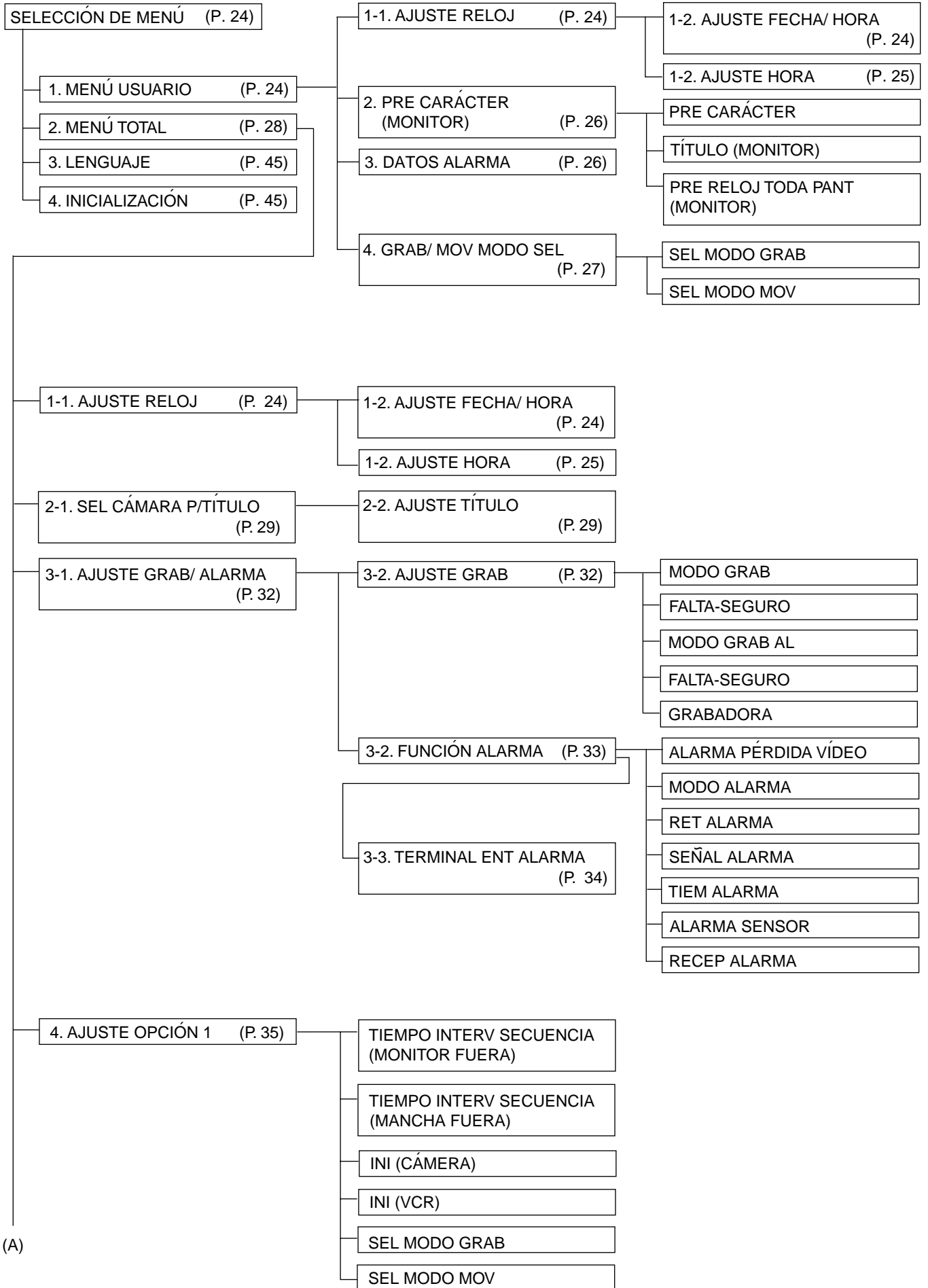

(A)

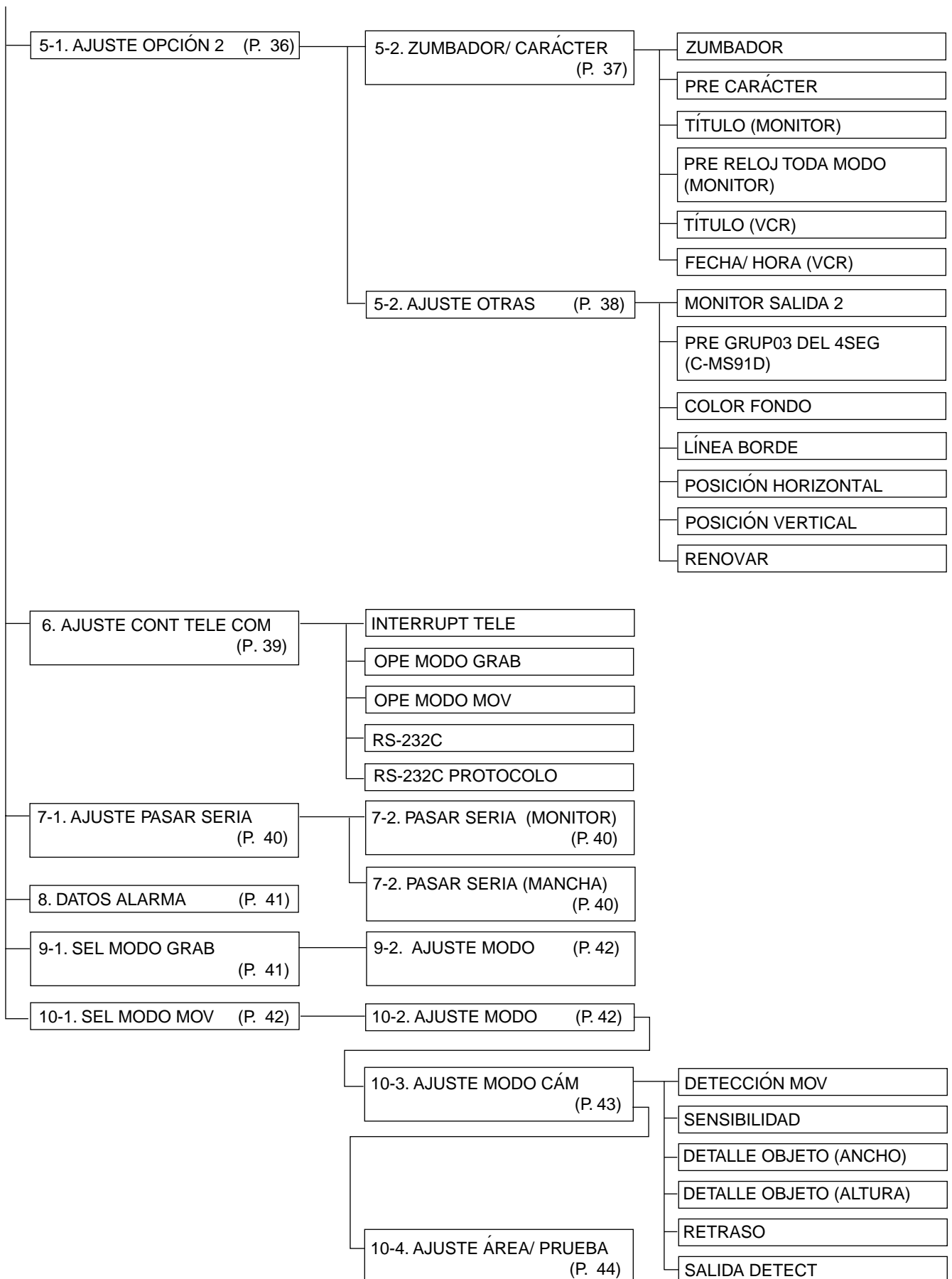

8.4. French menu

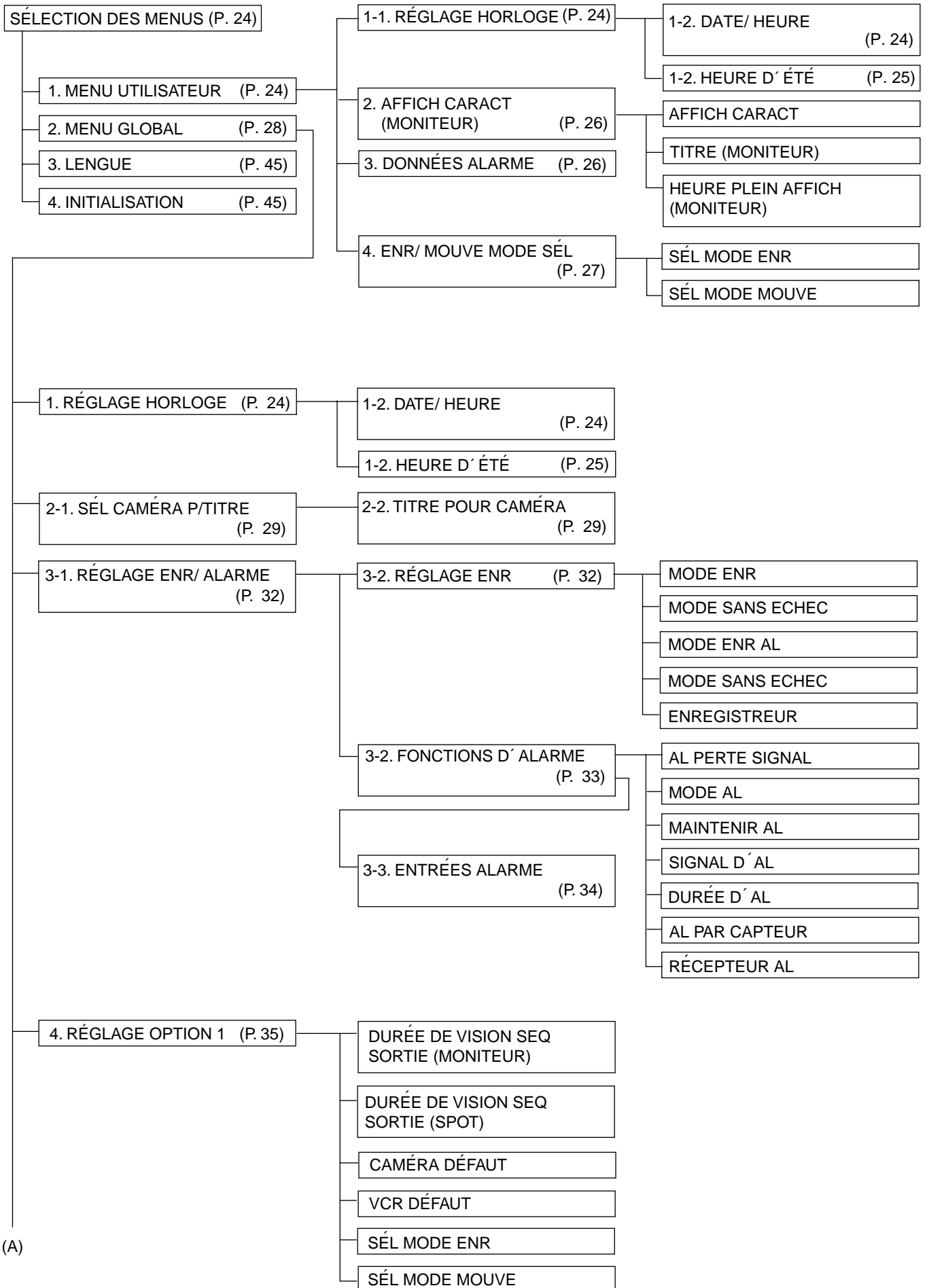

(A)

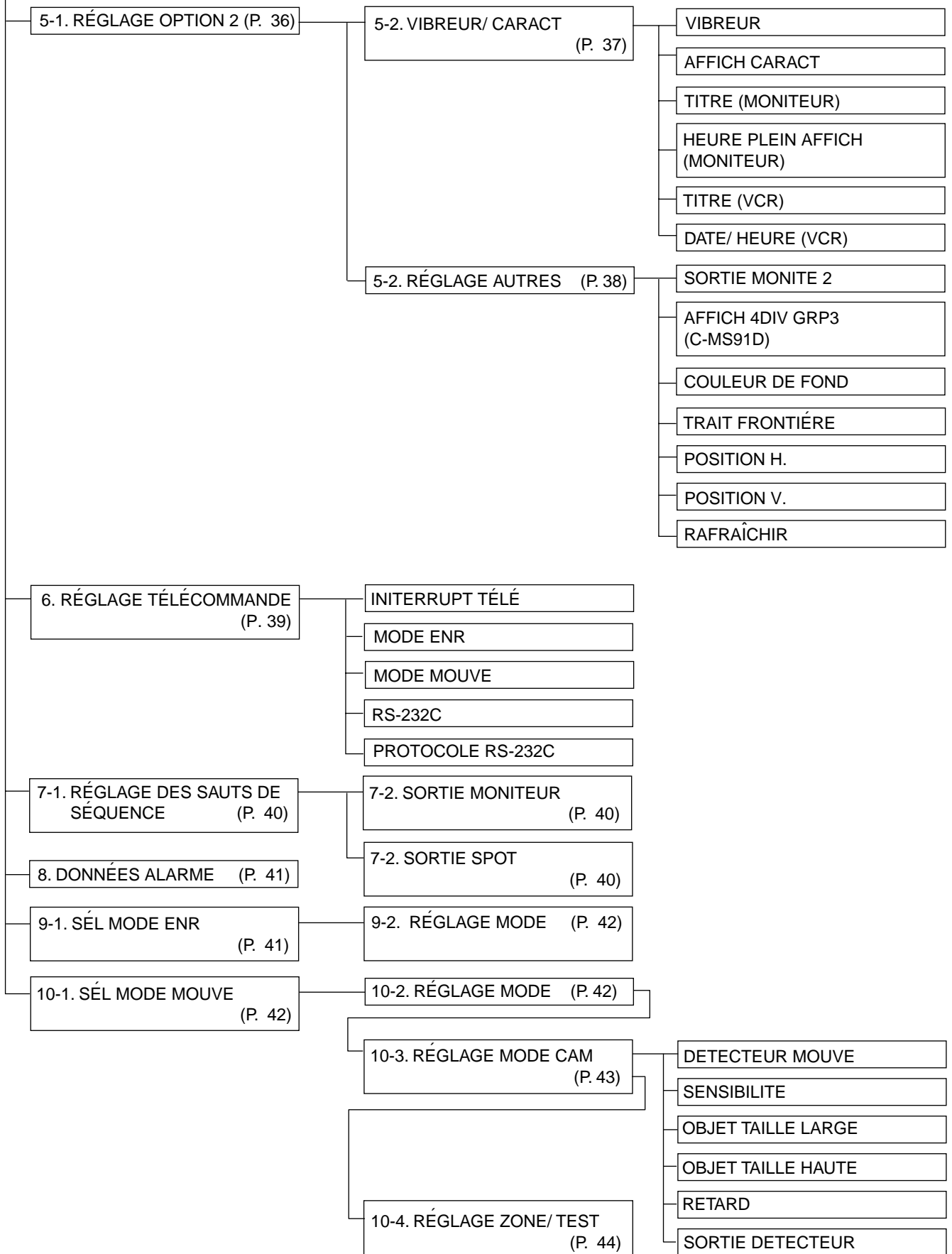

9. MENU SELECTION

9.1 Initial Menu Screen

On the screen displaying the camera, hold down the Menu key for one second or more to display the initial menu screen.

- Select the menu screen to be set from the 4 menu screen items on the initial menu screen.
- Move the cursor to the menu screen item with the shift keys, then display each menu screen (1 - 4) using the Selector key.

MENU SELECTION	
1 . USER MENU	P. 24
2 . TOTAL MENU	P. 28
3 . LANGUAGE	P. 45
4 . INITIALIZATION	P. 45

10. SETTINGS ON THE USER MENU SCREEN

10.1. User Menu User Menu

Items on this user menu are those which operators most frequently use from the total menu. First set all items on the total menu when installing the unit. (Refer to p. 28.) The following screen is displayed if "1. USER MENU" is selected on the initial menu screen.

- Move the cursor to the setting item with the shift keys, then display the setting screen with the Selector key.
- Pressing the Menu key returns the display to the initial menu screen.

USER MENU	
1 . CLOCK	P. 24
2 . CHARACTER DISPLAY (MONITOR)	P. 26
3 . ALARM DATA	P. 26
4 . REC / MOTION PTN SELECT	P. 27

10.2. Clock Settings User Menu

Set the date and time (in 24-hour format).

The following screen is displayed if "1. CLOCK" is selected on the user menu screen.

- Move the cursor to the desired setting item with the shift keys, then select the contents with the Selector key.
- Pressing the Menu key saves the set contents and returns the display to the user menu screen.
- The seconds reading automatically resets to "00" when the clock is set.
- The internal clock begins to operate from the set date and time when the Menu key is pressed.
- Use the following keys to enter values:
 - C-MS161D : Camera selector keys 1 - 10 (Key 10 to enter "0")
 - C-MS91D : Camera selector keys 1 - 9 and Spot selector key(to enter "0")

1 - 2 . DATE / TIME SETTING	
THU . SEP . 30 02	
23 : 59 : 59	

10.3. Summer time setting screen

[When the summer time has been set for OFF]

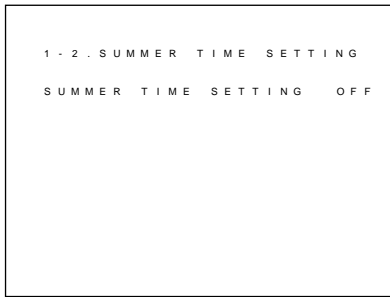

[When the summer time has been set for ON]

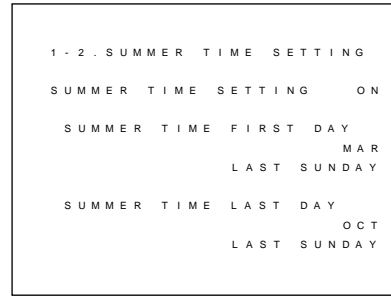

[Important] After the above setting has been performed, be sure to confirm that the on-screen current time is right. If it is out of order, correct the current time using "DATE/TIME SETTING."

- The above screen is displayed when "SUMMER TIME SETTING" is selected on [1-1. CLOCK SETTING] screen.
- Move the cursor to the desired item using the cursor control key (◀▶▲▼), then select the value with the selector key.
- Pressing the menu key stores the set value, and returns the screen to [1-1. CLOCK SETTING] screen.
- The following table shows the details of each setting value and its selection contents.

Setting item	Value	Contents
SUMMER TIME SETTING	ON/ <u>OFF</u>	ON: Displays the current date and time by automatically shifting the time from standard local time to summer time and from summer to standard time. OFF: Displays the current date and time having nothing to do with the summer time.
SUMMER TIME FIRST DAY	Month: JAN/ FEB/ <u>MAR</u> / APR/ MAY/ JUN / JUL/ AUG/ SEP / OCT/ NOV/ DEC Which Sunday: FIRST/ SECOND / THIRD/ FOURTH / <u>LAST</u>	Sets the time to shift to the summer time. Select the "month" and "which Sunday."
SUMMER TIME LAST DAY	Month: JAN/FEB/ <u>MAR</u> / APR/ MAY/ JUN / JUL/ AUG/ SEP / OCT/ NOV/ DEC Which Sunday: FIRST/ SECOND / THIRD/ FOURTH / <u>LAST</u>	Sets the time to shift back to the standard local time. Select the "month" and "which Sunday."

Note: Underlined settings represent factory-preset values.

10.4. Character Display (Monitor) User Menu

Set the monitor screen display contents.

The following screen is displayed if "2. CHARACTER DISPLAY (MONITOR)" is selected on the user menu screen.

- Move the cursor to the setting item with the shift keys, then select the contents with the Selector key.
- Pressing the Menu key saves the set contents and returns the display to the user menu screen.
- Shown below are individual setting items, selection contents and their details:

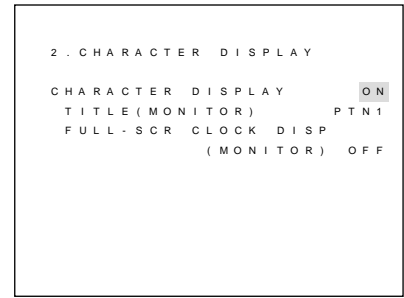

Setting Item	Value	Setting Contents
CHARACTER DISPLAY	<u>ON</u> / OFF	No characters are displayed on the monitor screen and VCR recorded images if the character display is set to OFF. Neither are the character indications "ALARM," "VL," and "FREEZE" displayed.
TITLE (MONITOR)	<u>PTN 1</u> / PTN 2/ OFF	Determines the monitor screen display contents. PTN 1 :Displays the camera number (for 9-segment and 16-segment split-screen displays, and the lower screens of the 10-segment split-screen display) and camera title (for full screen display, 4-segment split-screen display and the 2 upper screens of the 10-segment split-screen display) PTN 2 :Displays only the camera title (for full screen display, 4-segment split-screen display, and the 2 upper screens of the 10-segment split-screen display) OFF :Displays nothing.
FULL-SCR CLOCK DISP (MONITOR)	ON/ <u>OFF</u>	Set to ON to display the date and time on the full-screen monitor display.

Note: Underlined settings represent factory-preset settings.

10.5. Alarm Information User Menu

Activated Sensor, Motion Detection and Video Loss alarms can be stored for a total of up to 64 camera numbers, dates and times, and can be viewed on the alarm information screen. The following screen is displayed if "3. ALARM DATA" is selected on the user menu screen.

Initial screen(when there is no alarm data)

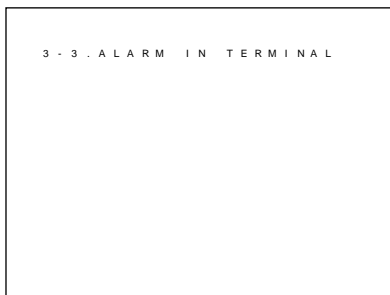

Alarm activation



Alarm information screen(example)

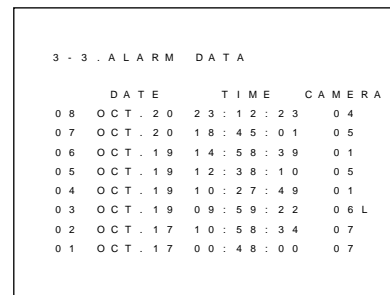

- Up to 8 alarm events can be simultaneously displayed on the screen. The screen first displays the most recent 8 alarms, which are chronologically numbered (above right).

Tips: Sensor alarm and Motion Detection alarm are indistinguishable from each other as displayed on the alarm information screen.

- Video Loss alarm camera numbers are displayed together with suffix "L." Sensor alarm or Motion detection alarm cameras are indicated by camera number alone.
 - When more than 64 Sensor, Motion Detection, and Video Loss alarms have been logged, the oldest data entries are deleted in chronological order.
 - Older data entries can be displayed with the Down (▼) key, and newer entries displayed with the Up (▲) key.
 - Press the Menu key to return to the user menu screen. (Refer to p. 65; Alarm Information Screen Example.)
- Note:** Pressing the Alarm reset key deletes all on-screen data.

10.6. Recording/Motion Pattern Selections User Menu

Set the recording patterns and motion detection patterns.

The following screen is displayed when "4. REC/MOTION PTN SELECT" is selected on the user menu screen.

- Move the cursor to the desired setting item with the shift keys, then select the contents with the Selector key.
- Pressing the Menu key saves the set contents, and returns the screen to the user menu screen.
- The following table shows the contents and details of each setting item.

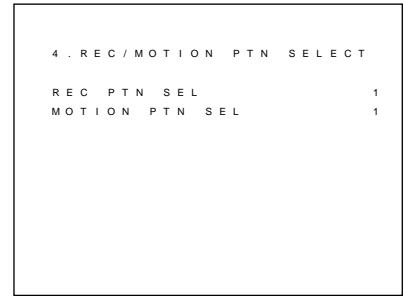

Setting Item	Value	Setting Contents
REC PTN SEL	<u>1</u> / 2 or (1)/(2)	<ul style="list-style-type: none"> • Select Recording Pattern 1 or 2 when "REC PTN OPE" of "6. REMOTE SETTING" on the total menu is set to "UNIT." (The number "1" or "2" is displayed.) • Either Recording Pattern 1 or 2, which has been selected from external equipment, is displayed when "REC PTN OPE" of "6. REMOTE SETTING" is set to "REMOTE" or "RS-232C." (The number "(1)" or "(2)" is displayed. The cursor does not move to this item, and the recording pattern cannot be selected on this screen.) <p>Note: The contents of Recording Patterns 1 and 2 are set in "9. REC PTN" on the total menu. (Refer to p. 39; Remote Control Settings and p. 41; Recording Pattern Settings.)</p>
MOTION PTN SEL	<u>1</u> / 2 or (1)/(2)	<ul style="list-style-type: none"> • Select Motion Detection Pattern 1 or 2 when "MOTION PTN OPE" of "6. REMOTE SETTING" on the total menu is set to "UNIT." (The number "1" or "2" is displayed.) • Either Motion Detection Pattern 1 or 2, which has been selected from external equipment, is displayed when "MOTION PTN OPE" of "6. REMOTE SETTING" is set to "REMOTE" or "RS-232C." (The number "(1)" or "(2)" is displayed. The cursor does not move to this item, and the motion detection pattern cannot be selected on this screen.) <p>Note: The contents of Motion Detection Patterns 1 and 2 are set in "10. MOTION" on the total menu. (Refer to p. 39; Remote Control Settings and p. 42; Motion Detection Pattern Settings.)</p>

Note: Underlined settings represent factory-preset settings.

11. TOTAL MENU SCREEN SETTINGS

11.1. Total Menu Total Menu

All setting items are displayed on the total menu screen. Set all items on this screen when installing the unit. The following screen is displayed when "2. TOTAL MENU" is selected on the initial menu screen.

- Move the cursor to the desired setting item with the shift keys, then display the setting screen with the Selector key.
- Pressing the Menu key saves the set contents, and returns the screen to the initial screen.

TOTAL MENU			
P. 28	1 . C L O C K	6 . R E M O T E	P. 39
P. 29	2 . T I T L E	7 . S E Q S K I P	P. 40
P. 32	3 . R E C / A L A R M	8 . A L D A T A	P. 41
P. 35	4 . O P T I O N 1	9 . R E C P T N	P. 41
P. 36	5 . O P T I O N 2	1 0 . M O T I O N	P. 42

11.2. Clock Settings Total Menu

Set the date and time (in 24-hour format). The following screen is displayed when "1. CLOCK" is selected on the total menu screen.

- Move the cursor to the desired setting item with the shift keys, then select the contents with the Selector key.
- Pressing the Menu key saves the set contents and returns the screen to the user menu screen.
- The seconds reading automatically resets to "00" when the clock is set.
- Pressing the Menu key causes the internal clock to begin operation from the set date and time.
- Use the following keys to enter values:
 - C-MS161D : Camera selector keys 1 - 10 (Key 10 to enter "0")
 - C-MS91D : Camera selector keys 1 - 9 and Spot selector key (to enter "0")

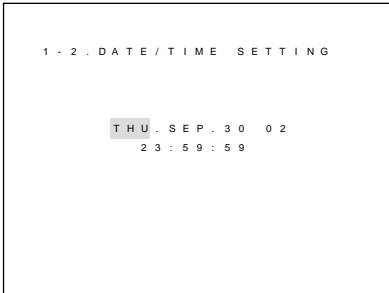

11.3. Title Settings Total Menu

Select the camera for which the camera title is to be set on the Title Setting Camera Selection screen, and set the title on the Title Setting screen.

11.3.1. Title Setting Camera Selection Screen

Select the camera for which the title is to be set.
The following screen is displayed when "2. TITLE" is selected on the screen.

Note: Setting items are not displayed for cameras 10 – 16 in the C-MS91D.

- Move the cursor to the camera for which the title is to be set, then display the title setting screen with the Selector key.
- The selected camera image is displayed in the background.
- When the selected camera is not connected, the screen displays the background color.
- Pressing the Menu key returns the screen to the total menu screen.

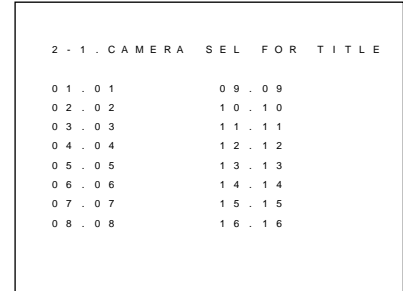

11.3.2. Title Setting Screen

Set each camera's title.
The following screen is displayed when the camera for which the title is set is selected on the title setting camera selection screen.

- Up to 8 characters can be used to enter the title.
- Pressing the menu key returns the screen to the title setting camera selection screen.

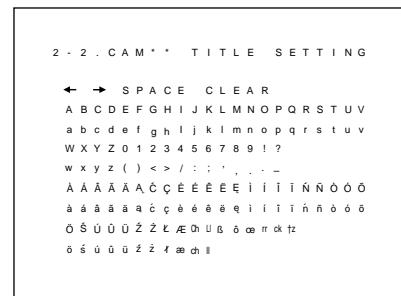

[Viewing the title setting screen]

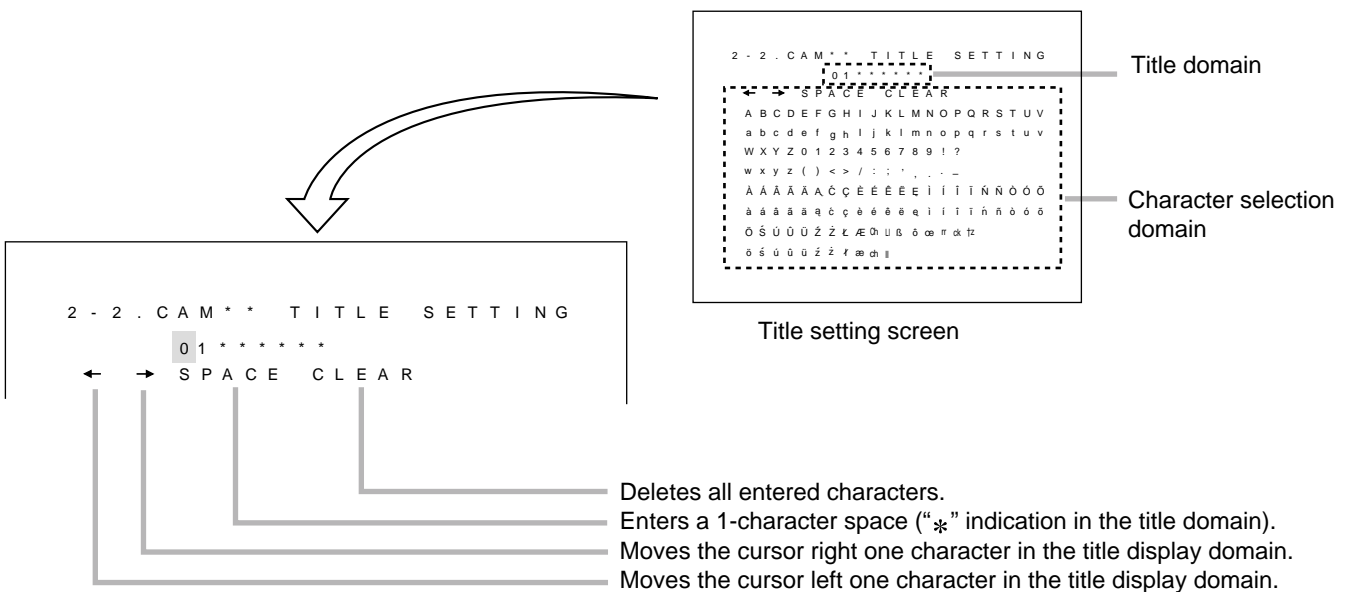

[Basic Character Entry Operations]

1. Move the cursor in the character selection domain with the shift keys.

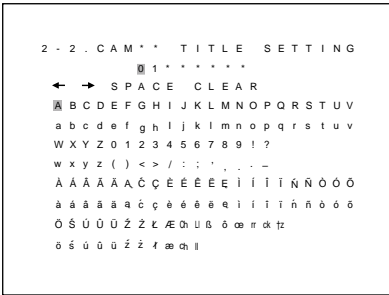

2. Press the Selector key.

The selected character is displayed in the cursor position in the title domain, and the cursor moves right one character.

If a character has already been entered in that position, the previous character is overwritten and changes to the selected character.

Note: The "*" mark in the title domain indicates that a character has not yet been entered.

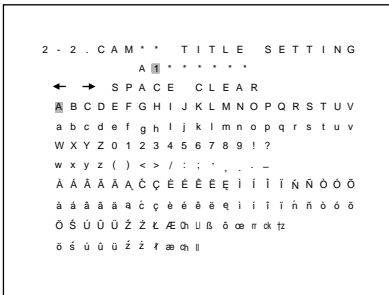

3. Repeat Steps 1 and 2 to enter the full title.

4. Press the Menu key after title entry completion.

The title is confirmed and the screen reverts to the Title Setting Camera Selection screen.

[Character Corrections]

1. Move the cursor in the character selection domain to "←" or "→" with the shift keys.

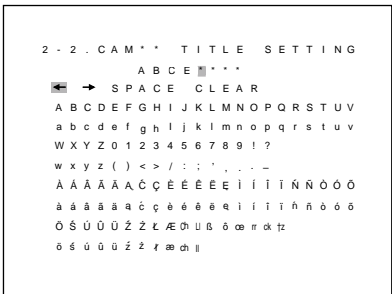

2. Press the Selector key.

The cursor in the title domain moves one character in the direction indicated by the arrow.

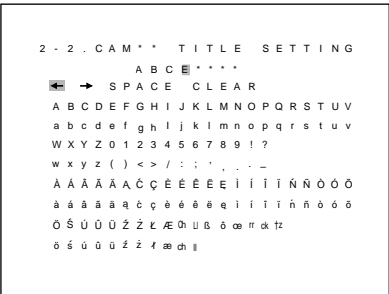

3. Repeat Steps 1 and 2 to move the cursor in the title domain to the character to be corrected.

4. Enter the character by following the basic character entry operation procedures in the previous section.

[Deleting Titles]

1. Move the cursor into the character selection domain to "CLEAR" with the shift keys.

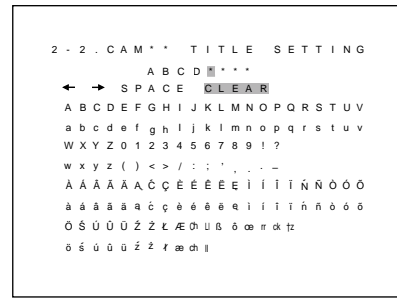

2. Press the Selector key.
All characters in the title domain are deleted, causing the " * * * * * " indication to be displayed.

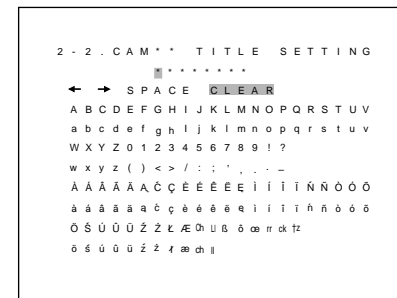

11.4. Recording/Alarm Settings Total Menu

Select either Recording Settings or Alarm Settings.

The following screen is displayed when "3. REC/ALARM" is selected on the total menu screen.

- Move the cursor to the desired setting item with the shift keys, then press the Selector key to display the setting screen.
- Pressing the Menu key returns the screen to the total menu screen.

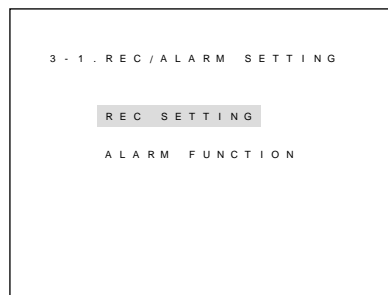

11.5. Recording Settings Total Menu

Perform settings related to video recording.

The following screen is displayed when "REC SETTING" is selected on the Recording/Alarm Setting screen.

Note: "FAIL-SAFE" items are only displayed when either the "REC MODE" or "ALARM REC MODE" is set to "T.L."

- Move the cursor to the desired setting item with the shift keys, then select the contents with the Selector key.
- Pressing the Menu key saves the set contents and returns the screen to the Recording/Alarm Setting screen.
- Shown below are values and contents of the individual setting items.

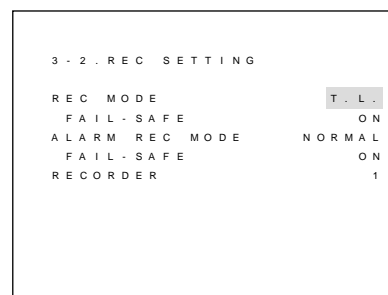

Setting Item	Value	Setting Contents
REC MODE	NORMAL/ <u>T.L.</u>	<p>NORMAL : Select this mode when recording in 2-hour or 6-hour mode using a time-lapse VCR, when recording by setting the digital recorder's recording interval to 1/60 sec., 1/30 sec. or 30FPS, or when using a home-use VCR (standard mode/3 times mode).</p> <p>T.L. : Select this mode when recording by setting a time-lapse VCR to any recording mode other than those noted above, or by setting a digital recorder to recording intervals other than those noted above.</p>
FAIL-SAFE	ON/ <u>OFF</u>	Set to ON to allow the camera to be automatically switched even if the Switcher control signal cable is broken when the recording mode is set to "T.L."
ALARM REC MODE	<u>Normal</u> / T.L.	<p>Set the recording mode for Sensor and Motion detection alarms.</p> <p>NORMAL : Select this mode when recording in 2-hour or 6-hour mode using a time-lapse VCR, when recording by setting the digital recorder's recording interval to 1/60 sec., 1/30 sec. or 30FPS, or when using a home-use VCR (standard mode/3 times mode).</p> <p>T.L. : Select this mode when recording by setting a time-lapse VCR to any recording mode other than those noted above, or by setting a digital recorder to recording intervals other than those noted above.</p>

Setting Item	Value	Setting Contents
FAIL-SAFE	ON/ <u>OFF</u>	Set to ON to allow the camera to be automatically switched even if the Switcher control signal cable is broken when the recording mode is set to "T.L."
RECORDER	<u>1</u> / 2	Normally set to "1." Set to "2" if the playback image rolls up and down and cannot be accurately played back in some connected recording devices.

Note

- Underlined settings represent factory-preset settings.
- Set the Auto Recognition function to OFF when using time-lapse recording intervals of 60 seconds or more.

11.6. Alarm Settings Total Menu

Perform settings related to the alarms.

The following screen is displayed when "ALARM FUNCTION" is selected on the Recording/Alarm Setting screen.

- Move the cursor to the desired setting item with the shift keys, then press the Selector key to display the setting screen.
- Pressing the Menu key saves the set contents and returns the screen to the Recording/Alarm Setting screen.
- Shown below are values and contents of the individual setting items:

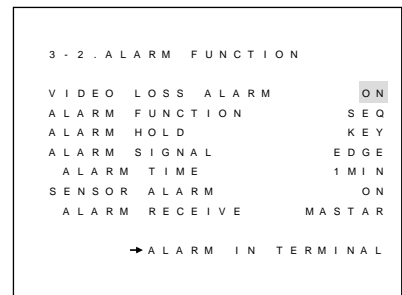

Setting Item	Value	Setting Contents
VIDEO LOSS ALARM	<u>ON</u> / OFF	Select ON when using Video Loss Alarm function. (Refer to p. 65; Video Loss Alarm.)
ALARM FUNCTION	<u>SEQ</u> / ALL/ LAST	Set alarm priorities assigned when multiple Sensor alarms or Motion Detection alarms are simultaneously triggered. (Refer to p. 62.) LAST : When multiple Sensor alarms or Motion Detection alarms are simultaneously triggered, the last-alarmed camera is displayed on the monitor. Only the last-alarmed camera is recorded by the connected VCR. SEQ : When multiple Sensor alarms or Motion Detection alarms are simultaneously triggered, all alarmed cameras are displayed in sequential order on the monitor, and all alarmed camera images are recorded by the connected VCR. ALL : When multiple Sensor alarms or Motion Detection alarms are simultaneously triggered, all alarmed cameras are displayed in sequential order on the monitor, and all connected camera images are recorded by the connected VCR.
ALARM HOLD	<u>KEY</u> / ALWAYS	This function disables the Alarm display whenever it is not desirable for the current on-screen camera to be switched to another camera upon Sensor or Motion Detection alarm input. Alarmed cameras are recorded on the connected VCR, but the monitor screen is not automatically switched to the alarmed cameras. (Refer to p. 61; Alarm Hold.) KEY : Pressing the Alarm Hold key on the front panel enables the Alarm Hold mode, as indicated by the lighting of the key's light. ALWAYS : The Multi-Switcher remains in the Alarm Hold mode regardless of the setting of the Alarm Hold key.

Setting Item	Value	Setting Contents
ALARM SIGNAL	<u>EDGE</u> / LEVEL	Set the activation method for Sensor and Motion Detection alarms. EDGE : Alarm is activated by shorting (or opening) the Alarm Input terminals. The Multi-Switcher is switched to Alarm mode for the interval set in the Alarm Time settings and cannot be disabled by opening (or shorting) the circuit until the interval expires. LEVEL : The Multi-Switcher remains in Alarm mode as long as the Alarm Input terminals are shorted (or opened). The alarm mode resets when the alarm input terminal circuit is opened (or shorted).
ALARM TIME	10SEC/ 15SEC / 20SEC/ 30SEC <u>1MIN</u> / 2MIN/ 3MIN / 4MIN/ 5MIN / No Limit	The alarm interval can only be set when the alarm signal is set to "Edge." Setting the alarm interval to "No Limit" keeps the Sensor alarm mode enabled until the Alarm Reset key is pressed.
SENSOR ALARM	<u>ON</u> / OFF	Set to ON to use the Sensor alarm function. (Refer to p. 59; Sensor Alarm.)
ALARM RECEIVE	<u>MASTER</u> / SLAVE	Select equipment to which the Sensor or Motion Detection alarm is input in the system employing the Multi-Switcher and its dedicated C-RM100 Remote Controller. MASTER : Select if alarm is input to the Multi-Switcher. SLAVE : Select if alarm is input to the C-RM100 by way of the C-AL80 Alarm Input Unit.

Note: Underlined settings represent factory-preset settings.

11.7. Alarm Input Terminal Settings Total Menu

Set "MAKE" or "BREAK" for each alarm input terminal.
Setting to "MAKE" activates the alarm when the terminal is shorted to ground. When set to "BREAK," the alarm is activated when the shorted terminal is opened. The following screen is displayed when "ALARM IN TERMINAL" is selected on the Alarm Setting screen.

Note: Alarm input terminals 10 – 16 are only available to the C-MS161D.

- Move the cursor to the desired setting item with the shift keys, then select the contents with the Selector key.
- Pressing the Menu key saves the set contents and returns the screen to the Alarm Setting screen.
- Set each of Alarm Input Terminals 1 - 16 to "MAKE" or "BREAK."
(Factory-preset setting: Make)

3 - 3 . ALARM IN TERMINAL	
01 MAKE	09 MAKE
02 MAKE	10 MAKE
03 MAKE	11 MAKE
04 MAKE	12 MAKE
05 MAKE	13 MAKE
06 MAKE	14 MAKE
07 MAKE	15 MAKE
08 MAKE	16 MAKE

11.8. Option 1 Settings Total Menu

Set the sequential display interval (dwell time) and monitor screen mode displayed when the power is switched on. The following screen is displayed when "4. OPTION 1" is selected on the total menu screen.

- Move the cursor to the desired setting item with the cursor control keys, then select the contents with the Selector key.
- Pressing the Menu key saves the set contents and returns the screen to the total menu screen.
- Shown below are the values and contents of each setting item:

```

4 . OPTION1  SETTING

SEQUENCE DWELL TIME
      MONITOR OUT  03 SEC
      SPOT OUT    03 SEC
INITIAL (CAMERA)  4 SEG SEQ
INITIAL (VCR)    * * * * *
REC PTN SEL      * * *
MOTION PTN SEL   * * *
    
```

Setting Item	Value		Setting Contents
	C-MS161D	C-MS91D	
SEQUENCE DWELL TIME (Monitor Out)	00 – 99 SEC* ¹ (03)		Set the dwell time for full-screen sequence and 4-segment split-screen sequence.* ²
SEQUENCE DWELL TIME (Spot Out)	0 – 99 SEC* ¹ (03)		Set Monitor Output 2 sequence dwell time when "MONITOR OUT 2" is set to Spot on the Other Settings screen.* ²
INITIAL (CAMERA)	FULL 1 –16 SEQ 4 SEG 1 4 SEG 2 4 SEG 3 4 SEG 4 <u>4 SEG SEQ</u> 9 SEG 1 9 SEG 2 10 SEG 1 10 SEG 2 16 SEG	FULL 1 – 9 SEQ 4 SEG 1 4 SEG 2 <u>4 SEG SEQ</u> 9 SEG 10 SEG	The screen set here is displayed on the monitor when the Camera mode is used for the first time after the power is switched on. Setting contents are as follows: FULL 1–16 (9): Full-screen display of designated camera number. 4 SEG 1 : 4-segment split display of camera group 1. 4 SEG 2 : 4-segment split display of camera group 2. 4 SEG 3 : 4-segment split display of camera group 3. 4 SEG 4 : 4-segment split display of camera group 4. 4 SEG SEQ : 4-segment split sequential display. 9 SEG 1 : 9-segment split display of camera group 1. 9 SEG 2 : 9-segment split display of camera group 2. 10 SEG 1 : 10-segment split display of camera group 1. 10 SEG 2 : 10-segment split display of camera group 2. 16 SEG : 16-segment split display of cameras 1 – 16.
INITIAL (VCR)	FULL 1 –16 <u>4 SEG1</u> 4 SEG 2 4SEG 3 4 SEG 4 9 SEG 1 9 SEG 2 16 SEG	FULL 1 – 9 <u>4 SEG 1</u> 4 SEG2 9 SEG	The screen set here is displayed on the monitor when VCR mode is used for the first time after the power has been switched on. Setting contents are as follows: FULL 1–16 (9): Full-screen display of designated camera number. 4 SEG 1 : 4-segment split display of camera group 1. 4 SEG 2 : 4-segment split display of camera group 2. 4 SEG 3 : 4-segment split display of camera group 3. 4 SEG 4 : 4-segment split display of camera group 4. 9 SEG 1 : 9-segment split display of camera group 1. 9 SEG 2 : 9-segment split display of camera group 2. 16 SEG : 16-segment split display of cameras 1 – 16.

Note

*¹ Values can also be entered using the following keys:

C-MS161D : Camera selector keys 1 – 10 (Key 10 to enter "0")

C-MS91D : Camera selector keys 1 – 9 and Spot selector key (to enter "0")

*² If set to "00," cameras are sequentially switched in response to signals received at the Sequence input terminal of the Remote Input/Output terminals.

Setting Item	Value	Setting Contents
REC PTN SEL	<u>1</u> / 2 or (1)/(2)	<ul style="list-style-type: none"> • Select Recording Pattern 1 or 2 when "REC PTN OPE" of "6. REMOTE SETTING" on the total menu is set to "UNIT." (The number "1" or "2" is displayed.) • Either Recording Pattern 1 or 2, which has been selected from external equipment, is displayed when "REC PTN OPE" of "6. REMOTE SETTING" is set to "REMOTE" or "RS-232C." (The number "(1)" or "(2)" is displayed. The cursor does not move to this item, and the recording pattern cannot be selected on this screen.) <p>Note: The contents of Recording Patterns 1 and 2 are set in "9. REC PTN" on the total menu. (Refer to p. 39; Remote Control Settings and p. 41; Recording Pattern Settings.)</p>
MOTION PTN SEL	<u>1</u> / 2 or (1)/(2)	<ul style="list-style-type: none"> • Select Motion Detection Pattern 1 or 2 when "MOTION PTN OPE" of "6. REMOTE SETTING" on the total menu is set to "UNIT." (The number "1" or "2" is displayed.) • Either Motion Detection Pattern 1 or 2, which has been selected from external equipment, is displayed when "MOTION PTN OPE" of "6. REMOTE SETTING" is set to "REMOTE" or "RS-232C." (The number "(1)" or "(2)" is displayed. The cursor does not move to this item, and the motion detection pattern cannot be selected on this screen.) <p>Note: The contents of Motion Detection Patterns 1 and 2 are set in "10. Motion Detection Pattern" on the total menu. (Refer to p. 39; Remote Control Settings and p. 42; Motion Detection Pattern Settings.)</p>

Note: Underlined settings represent factory-preset settings.

11.9. Option 2 Settings Total Menu

Perform settings for the buzzer, character display and other settings. The following screen is displayed when TOTAL MENU → 5. OPTION 2 is selected.

- Move the cursor to the desired setting item with the cursor control keys, then select the setting screen with the Selector key.
- Pressing the Menu key returns the screen to the total menu screen.

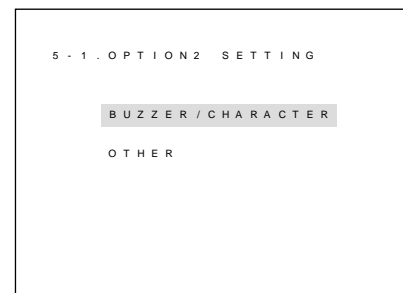

11.10. Buzzer/Character Display Settings

Total Menu

Input characters to be displayed on the monitor or recorded images, and set the buzzer for triggered alarms. The following screen is displayed when 5. OPTION 2 → BUZZER/CHARACTER is selected:

Note: Four items under the item "CHARACTER DISPLAY" are only displayed when "CHARACTER DISPLAY" is set to ON.

- Move the cursor to the desired setting item with the cursor control keys, then select the contents with the Selector key.
- Pressing the Menu key saves the set contents and returns the screen to the Option 2 setting screen.
- Shown below are the values and contents of each setting item.

```

5 - 2 . BUZZER / CHARACTER

BUZZER                                ON
CHARACTER DISPLAY                     ON
TITLE (MONITOR)                       PAT 1
FULL-SCR CLOCK DISP (MONITOR)        OFF
TITLE (VCR)                           PAT 1
DATE / TIME (VCR)                     ON
    
```

Setting Item	Value	Setting Contents
BUZZER	<u>ON</u> / OFF	Select ON to sound a buzzer during Sensor, Motion Detection, or VCR Playback alarm.
CHARACTER DISPLAY	<u>ON</u> / OFF	When OFF is selected, characters are not displayed on the VCR-recorded camera images, including such warning indications as "ALARM," "V.L," and "FREEZE."
TITLE (MONITOR)	<u>PTN 1</u> / PTN 2/ OFF	This setting determines the indication contents to be displayed on the monitor screen. PTN 1 : Displays camera number (during 9- or 16-segment split-screen displays, or on the lower screens of 10-segment split-screen display) and camera title during full-screen or 4-segment split screen displays or on 2 upper screens of 10-segment split-screen display). PTN 2 : Displays only camera title (during full screen or 4-segment split-screen displays, or on 2 upper screens of 10-segment split-screen display). OFF : Nothing displayed.
FULL-SCR CLOCK DISP (MONITOR)	ON/ <u>OFF</u>	Select ON to keep both date and time displayed full-screen on the monitor.
TITLE (VCR)	<u>PTN 1</u> / PTN 2/ OFF	This setting determines the indication contents to be displayed on the VCR-recorded image. PTN 1 : Displays title and alarm-related indications.* PTN 2 : Displays only title. (Alarm-related indications not displayed.) OFF : Nothing displayed.
DATE/TIME (VCR)	<u>ON</u> / OFF	Select ON to display date and time on the VCR-recorded image.

* The alarm indication is not recorded when the Alarm Function is set to "LAST" in the alarm setting.

Note: Underlined settings represent factory-preset settings.

11.11. Other Settings Total Menu

Perform settings of Monitor output 2, background color, etc.

The following screen is displayed when "OTHER" is selected on the Option 2 setting screen.

Note: The item "4-SEG GROUP 3 DISP" is only displayed when the C-MS91D Multi-Switcher is used.

- Move the cursor to the desired setting item with the cursor control keys, then select the contents with the Selector key.
- Pressing the Menu key stores the set contents and returns the screen to the Option 2 Setting screen.
- Shown below are the values and contents of each setting item.

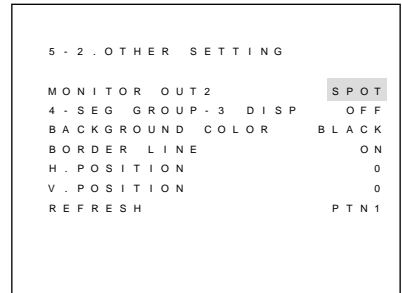

Setting Item	Value	Setting Contents
MONITOR OUT 2	<u>SPOT</u> / OUTPUT 1	Set Monitor Output 2 display mode. SPOT : Displays all camera images other than those of Monitor Output 1 on the full screen or in sequential order. OUTPUT 1 : The same camera image is output to Monitor Output 1 and Monitor Output 2.
4-SEG GROUP 3 DISP	ON/ <u>OFF</u>	Setting item for the C-MS91D only. Select ON to display Camera Group 3 during 4-segment split-screen display or 4-segment split-screen sequential display. ON : Camera groups are displayed as follows during 4-segment split-screen display or 4-segment split-screen sequential display: Group 1 (Factory-preset setting: Cameras 1 – 4) ← ↓ Group 2 (Factory-preset setting: Cameras 5 – 8) ↓ Group 3 (Factory-preset setting: Camera 9) ——— OFF : Camera groups are displayed as follows during 4-segment split-screen display or 4-segment split-screen sequential display: Group 1 (Factory-preset setting: Cameras 1 – 4) ← ↓ Group 2 (Factory-preset setting: Cameras 5 – 8) ———
BACKGROUND COLOR	<u>BLACK</u> / BLUE	When an unconnected or unrecorded camera is selected, the background color is displayed on the screen. In this setting, either black or blue is selected.
BORDER LINE (NTSC only)	<u>ON</u> / OFF	Set borderlines between split-image screens. ON : Displays a gray border line. OFF : Displays no border line.
H. POSITION	-7 – +7 (0)	Adjust the horizontal display position of split-screen displays. Some monitors do not permit the split-screen display to be precisely positioned in the center of the screen. In such cases, adjust the horizontal position with the Selector keys.
V. POSITION	-7 – +7 (0)	Adjust the vertical display position of split-screen displays. Some monitors do not permit the split-screen display to be precisely positioned in the center of the screen. In such cases, adjust the vertical position with the Selector keys.
REFRESH	<u>PTN 1</u> / PTN 2	Select Pattern 1 normally. When the image is distorted, it may be improved if Pattern 2 is selected.

11.12. Remote Control Settings Total Menu

Perform settings related to remote control functions. The following screen is displayed when TOTAL MENU → 6. REMOTE is selected:

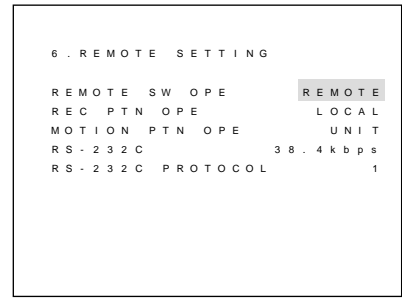

- Move the cursor to the desired setting item with the cursor control keys, then select the contents with the Selector key.
- Pressing the Menu key saves the set contents and returns the screen to the Total Menu screen.
- Shown below are the values and contents of each setting item.

Setting Item	Value	Setting Contents
REMOTE SW OPE	<u>LOCAL</u> / REMOTE	Determines whether the Camera/VCR mode selector and VCR selector switches are operated at the Multi-Switcher or at connected external equipment. (Refer to p. 67; Remote Control Function.) LOCAL : Both switches are operated using the Multi-Switcher's front panel-mounted keys. REMOTE : Both switches are operated by external equipment. Note: All keys other than the Camera/VCR mode selector switch and VCR selector switch can always be remotely operated.
REC PTN OPE	<u>UNIT</u> / EXT/ RS-232C	Select the method of selecting Recording Pattern 1 or 2 through Total Menu → 9. REC PTN from among a) Multi-Switcher setting, b) remote control by external equipment and c) remote control by way of the RS-232C connector. (Refer to p. 77; Recording Pattern Function.) UNIT : Select Recording Pattern 1 or 2 through Total Menu → 4. OPTION 1 → REC PTN SEL. EXT : Recording Pattern 1 or 2 is remotely selected by connected external equipment. (Refer to p. 72; Recording Pattern Selection Input Terminal.) RS-232C : Recording Pattern 1 or 2 is remotely selected by an external computer or Remote Controller by way of the RS-232C connector.
MOTION PTN OPE	<u>UNIT</u> / EXT/ RS-232C	Select the method of selecting Motion Detection Pattern 1 or 2 through Total Menu → 10. MOTION from among a) Multi-Switcher setting, b) remote control by external equipment and c) remote control by way of the RS-232C connector. (Refer to p. 76; Motion Detection Pattern Function.) UNIT : Select Motion detection pattern 1 or 2 through Total Menu → 4. OPTION 1 → MOTION PTN SEL. EXT : Motion Detection Pattern 1 or 2 is remotely selected by connected external equipment. (Refer to p. 72; Motion Detection Pattern Selection Input Terminals.) RS-232C : Motion Detection Pattern 1 or 2 is remotely selected by an external computer or Remote Controller by way of the RS-232C connector.
RS-232C	2.4 kbps 4.8 kbps 9.6 kbps 19.2 kbps <u>38.4 kbps</u>	Set the transmission speed for the RS-232C connector. The following connector parameters are fixed, and cannot be changed: Parity : Even number Stop bit : 1 bit Data bit length : 8 bits
RS-232C PROTOCOL	<u>1</u> / 2	1: Select when controlled by a PC through the RS-232C connector. 2: Select when connecting the dedicated C-RM100 Remote Controller to the RS-232C terminal.

Note: Underlined settings represent factory-preset settings.

11.13. Sequential Display Skip Settings Total Menu

Select the Monitor output or Spot output for which the skip setting is performed. The following screen is displayed when TOTAL MENU → 7. SEQ SKIP is selected.

- Move the cursor to the desired setting item with the cursor control keys and select the item with the Selector key.
- Pressing the Menu key returns the screen to the total menu screen.

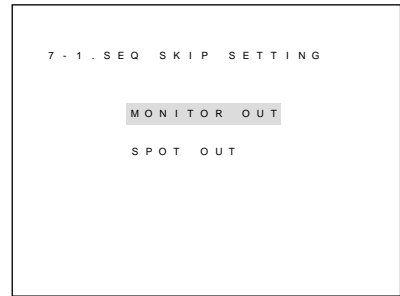

11.14. Monitor Output Sequential Display Skip Settings Total Menu

Perform the sequential display skip setting for the Monitor output. The following screen is displayed when "MONITOR OUT" is selected on the sequential display skip setting screen:

- Move the cursor to the desired setting item with the cursor control keys, then select the contents with the Selector key.
- Pressing the Menu key saves the set contents and returns the screen to the sequential display skip setting screen.
- Unconnected cameras are automatically skipped during full-screen sequential display. Select ON to forcibly skip cameras connected to the Monitor output. (Factory-preset setting: OFF)

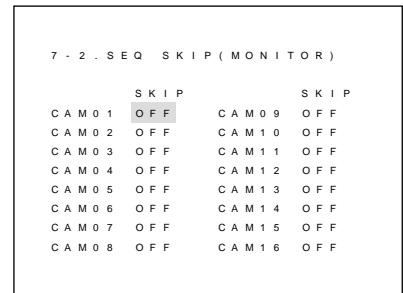

11.15. Spot Output Sequential Display Skip Settings Total Menu

Perform the sequential display skip setting for the Spot output. The following screen is displayed when "Spot Output" is selected on the sequential display skip setting screen:

- Move the cursor to the desired setting item with the cursor control keys, then select the contents with the Selector key.
- Pressing the Menu key saves the set contents and returns the screen to the sequential display skip setting screen.
- Unconnected cameras are automatically skipped during sequential display on the full screen. Select ON to forcibly skip cameras connected to the Spot output. (Factory-preset setting: OFF)

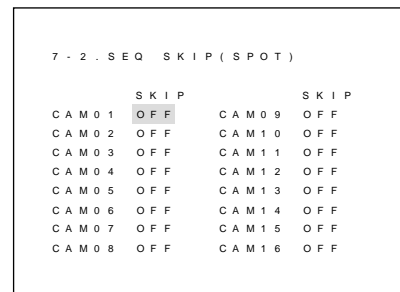

11.16. Alarm Information Total Menu

Activated Sensor alarm, Motion detection alarm and Video loss alarm can be stored for up to a full of 64 of camera numbers, dates and times, and can be viewed on the alarm information screen. The following screen is displayed if User Menu → 8. AL DATA is selected.

Initial screen(when there is no alarm data)

8 . ALARM DATA			
DATE	TIME	CAMERA	

Alarm activation
→

Alarm information screen(example)

8 . ALARM DATA			
DATE	TIME	CAMERA	
08	OCT . 20	23 : 12 : 23	04
07	OCT . 20	18 : 45 : 01	05
06	OCT . 19	14 : 58 : 39	01
05	OCT . 19	12 : 38 : 10	05
04	OCT . 19	10 : 27 : 49	01
03	OCT . 19	09 : 59 : 22	06 L
02	OCT . 17	10 : 58 : 34	07
01	OCT . 17	00 : 48 : 00	07

- Up to 8 alarm events can be simultaneously displayed on the screen. The screen first displays the most recent 8 alarms, which are chronologically numbered (above right figure).
Tips: Sensor alarm and Motion detection alarm are indistinguishable from each other as displayed on the alarm information screen.
- Video loss alarm camera number is displayed together with suffix "L." Sensor alarm or Motion detection alarm cameras are indicated by a straight camera number.
- When more than 64 Sensor, Motion Detection, and Video Loss alarms have been logged, the oldest data entries are deleted in chronological order.
- Older data entries can be displayed with the Down (▼) key, and newer entries displayed with the Up (▲)key.
- Press the Menu key to return to the user menu screen. (Refer to p. 65; Alarm Information Screen Example.)
Note: Pressing the Alarm reset key deletes all on-screen data.

11.17. Recording Pattern Settings Total Menu

Two different camera recording patterns can be set. Use this function when different cameras need to be recorded in the daytime and nighttime or on holidays and workdays.

11.17.1. Recording Pattern Setting Screen

Select the recording pattern to be set.

The following screen is displayed when TOTAL MENU → 9. REC PTN is selected on the total menu screen.

- Move the cursor with the cursor control keys to select "PATTERN 1" or "PATTERN 2" with the Selector key. Recording pattern setting screen 1 or 2 will then be displayed.
- Pressing the Menu key returns the screen to the total menu screen.

9 . 1 . REC PATTERN SETTING	
PATTERN 1	PATTERN 2

11.17.2. Individual Recording Pattern Setting Screen

Set individual recording patterns.

The following screen is displayed when "PATTERN 1" or "PATTERN 2" is selected on the recording pattern setting screen.

Note: Selection items for Cameras 10 – 16 are not displayed by the C-MS91D.

- Move the cursor with the cursor control keys and select ON for cameras to be used, and OFF for cameras not to be used with the Selector key. (Factory-preset setting: OFF for all cameras in both Patterns 1 and 2.)
- Pressing the Menu key saves the set contents and returns the screen to the recording pattern setting screen.

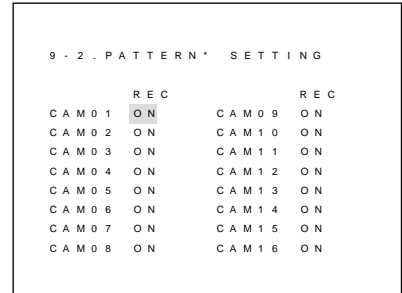

11.18. Motion Detection Pattern Settings Total Menu

Two different detection patterns can be set. Use this function when different cameras need to be recorded in daytime and nighttime, or on holidays and workdays.

11.18.1. Motion Detection Pattern Setting Screen

Select the motion detection pattern to be set.

The following screen is displayed when TOTAL MENU → MOTION is selected.

- Move the cursor with the cursor control keys and select "PATTERN 1" or "PATTERN 2" with the Selector key. The camera setting screen for motion detection pattern 1 or pattern 2 will then be displayed.
- Pressing the Menu key returns the screen to the total menu screen.

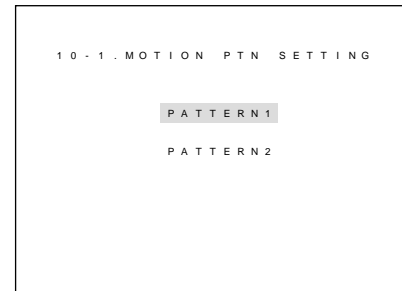

11.18.2. Motion Detection Pattern Camera Setting Screen

Select the camera for which the Motion Detection pattern is set.

The following screen is displayed when "PATTERN 1" or "PATTERN 2" is displayed on the Motion Detection Pattern setting screen.

Note: Selection items for Cameras 10 – 16 are not displayed by the C-MS91D.

- Move the cursor with the cursor control keys and select the camera to be set with the Selector key. The setting screen for Pattern 1 or 2 for the selected camera will then be displayed.
- Pressing the Menu key returns the screen to the motion detection pattern setting screen.

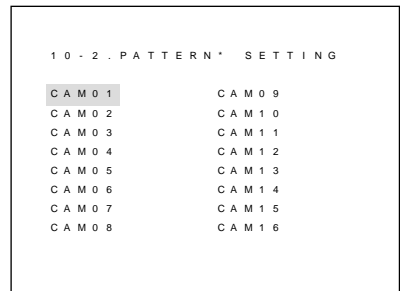

11.18.3. Camera Motion Detection Pattern Setting Screen

Set the Motion Detection Pattern for the selected camera.

Each camera's setting screen is displayed when the camera is selected on the Motion Detection Pattern Camera setting screen.

Note: Other setting items are not displayed when the Motion Detection function is set to OFF.

- Move the cursor with the cursor control keys and select the contents with the Selector key. If "AREA SETTING/TEST" is selected, the area setting/test screen is displayed
- Pressing the Menu key saves the set contents and returns the screen to the Motion Detection Pattern setting screen.
- Shown below are the values and contents of each setting item:

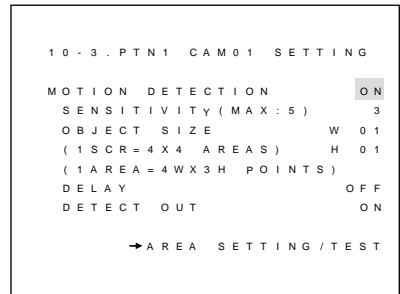

Setting Item	Value	Setting Contents
MOTION DETECTION	ON/ AL(OR)/ AL(AND)/ <u>OFF</u>	Determines whether or not to use a motion detection signal, and if using, whether to set the Motion Detection alarm or Sensor alarm.(Refer to p. 73; Motion Detection.) ON : Increases recording speed when a motion detection signal is received. (Not operated as alarm.) Alarm (OR): Alarm is activated when either a motion detection alarm or Sensor alarm signal is received. (Recording speed remains unchanged.) Alarm (AND): Alarm is activated when both a motion detection alarm and a Sensor alarm signal are received. (Recording speed remains unchanged.) OFF: Disables the motion detection function.
Detection sensitivity (Maximum 5)	1 – 5 (<u>3</u>)	Set the detection sensitivity. The sensitivity goes up as the number increases. (Refer to p. 74; Detection Sensitivity.)
Detection area size (1 screen: 4 x 4 areas) (1 area: 4 horizontal x 3 vertical frames)	<u>1</u> – 16 W (horizontal)	(1 – 16 horizontal) Set the horizontal size of the detection frame. The maximum number of horizontal frames on the full screen is 16. (Refer to p. 74; Detection Size.)
	<u>1</u> – 12 H (vertical)	(1 – 12 vertical) Set the vertical size of the detection frame. The maximum number of vertical frames on the full screen is 12. (Refer to p. 74; Detection Size.)
Detection standby time	<u>OFF</u> /0.5sec/1sec/2sec/3sec/5sec	Set the time interval from detecting a change in motion till the start of its processing. (Refer to p. 74; Detection Standby Time.)
Detection output	<u>ON</u> /OFF	Set the detection output.

Note: Underlined settings represent factory-preset settings.

[Motion Detection Frame Size Settings]

- When the motion detection frame size is set, motion or position changes are detected if a subject that moved is larger than the set frame size. The changes are ignored if the subject is smaller than the set frame size.
- The full screen is divided into 16 horizontal x 12 vertical frames (192 frames in all), which do not appear on the display. The size of a single area of the "Area Setting/Test Screen" corresponds to 4 horizontal x 3 vertical frames.

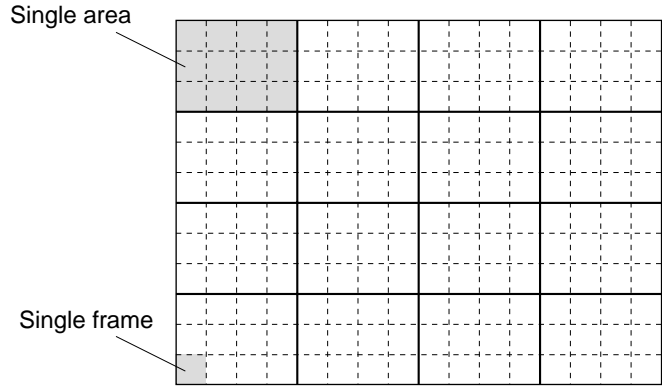

- For example, when wishing to detect a person but not wishing to detect a small animal, such as a cat, set the detection area size to be larger than the animal and smaller than a person. If the size is set for 2 horizontal x 5 vertical frames, such as in the figure at right, motion or position changes by the person can be detected, but motion or position changes by the cat are ignored (not detected).

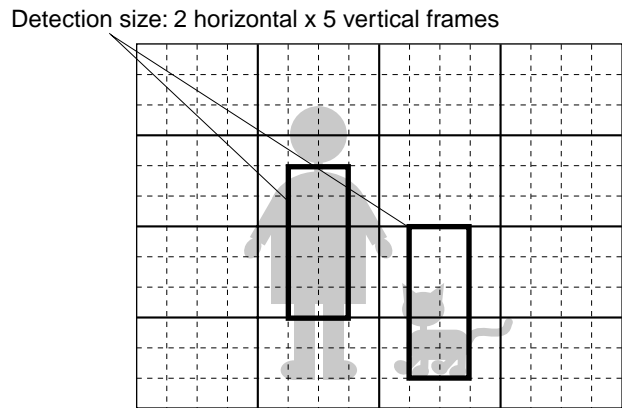

11.18.4. Area Setting/Test Screen

- The screen shown in the figure at right is displayed when "AREA SETTING/TEST" is selected on the Motion Detection Pattern setting screen.
- Move the cursor with the cursor control keys and select the contents with the Selector key. (The display toggles between ON and OFF (- -) with each depression of the Selector key.) All setting areas are factory-preset to OFF (- -).
- Pressing the Menu key saves the set contents and returns the screen to the Motion Detection pattern (individual cameras) screen.

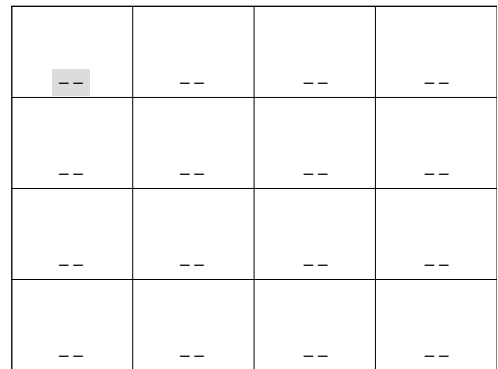

[Motion Detection Area Settings]

- Select ON for areas to be used for Motion Detection, and OFF (- -) for areas not used. For example, when wishing to eliminate constantly moving portions of the monitored image (such as trees swaying by wind) from the Motion Detection area, set the corresponding area to OFF(- -).

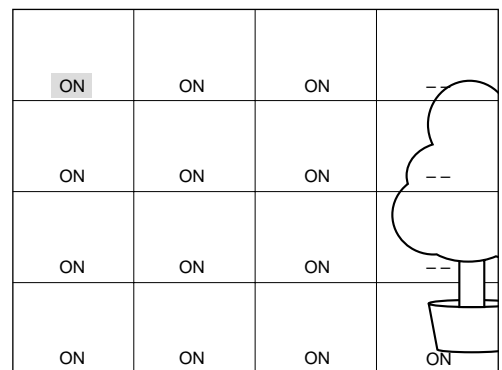

[Motion Detection Function Test]

- Have a person actually move in front of the camera to test to see that only subjects that should be detected can be detected as intended.
- When motion or a change in position is detected, the " ■ " indications light as shown in the figure at right.
- If position changes cannot be detected as intended, change the a) detection sensitivity, b) detection frame size, c) detection standby time and d) detection area settings, then perform the test again.

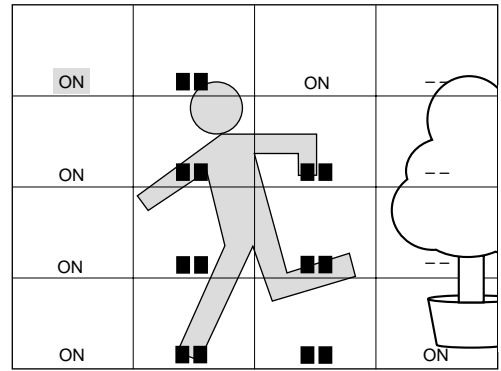

12. CHANGING THE DISPLAY LANGUAGE

The display language on the menu screen can be changed. The following screen is displayed when Initial Menu → 3. LANGUAGE is selected.

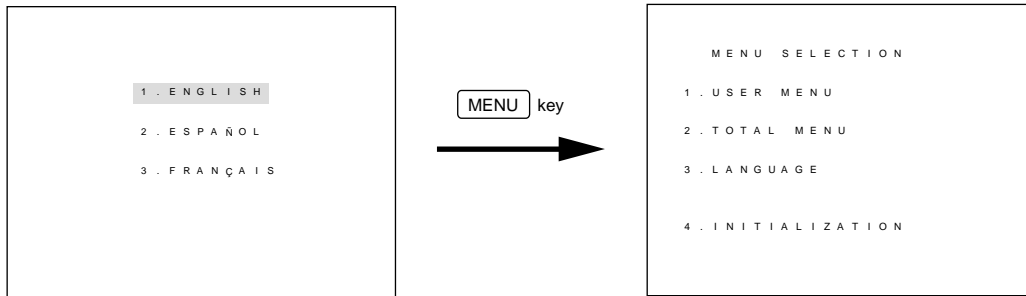

- Select the setting contents with the Selector key and press the Menu key to display the initial menu screen for the selected language.
- Selecting "ENGLISH" allows the initial English menu screen (above right figure) to appear, displaying all menu screens and setting screens in the English writing system.

13. INITIALIZING SETTING CONTENTS

All settings can be returned to their factory-preset status by erasing the settings on the menu screen. The initialization screen (below left) is displayed when Initial Menu → 4. INITIALIZATION is selected.

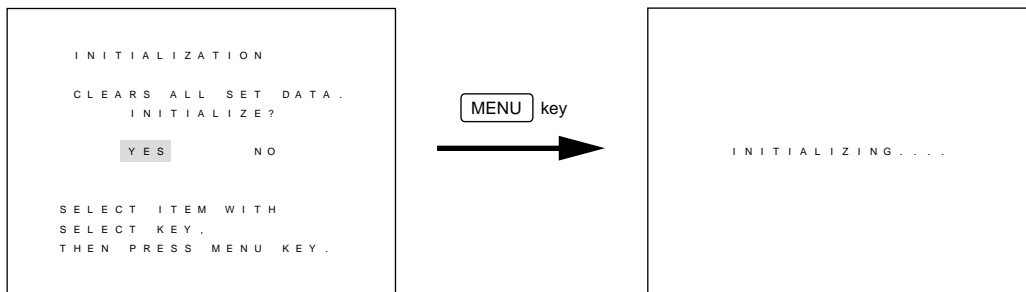

- Select the setting contents with the Selector key.
- Select "YES" and press the Menu key. The "INITIALIZING" indication (above right figure) will then be displayed, and the display returns to the Initial Menu screen after all setting data has been initialized.
- If "NO" is selected and the Menu key pressed, the display returns to the Initial Menu screen without initializing the settings.

Note: Date/time and language settings are not initialized.

14. CHANGING CAMERA ARRANGEMENT ON MULTI-SCREEN DISPLAYS

Multi-screen camera arrangements on the 4-segment, 9-segment, 10-segment and 16-segment (C-MS161D only) split screens in Camera mode can be changed by selecting the cameras to be displayed.

1. Press the 4-Segment Split Display key () while holding down the Spot Selector key.

- The Spot Selector key lights and the 4-Segment Split Display key or Multi-screen Key flashes.
- Camera numbers are displayed on the screen, and the cursor position flashes.

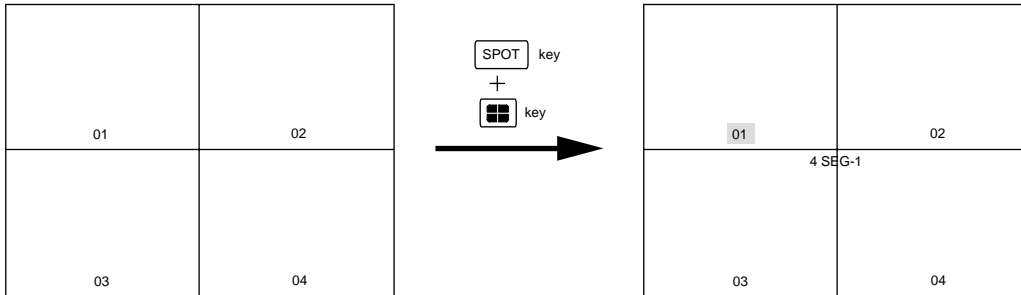





Note

- The [] section in the figure indicates the cursor. Character display flashes.
- The figure shows a C-MS161D display.

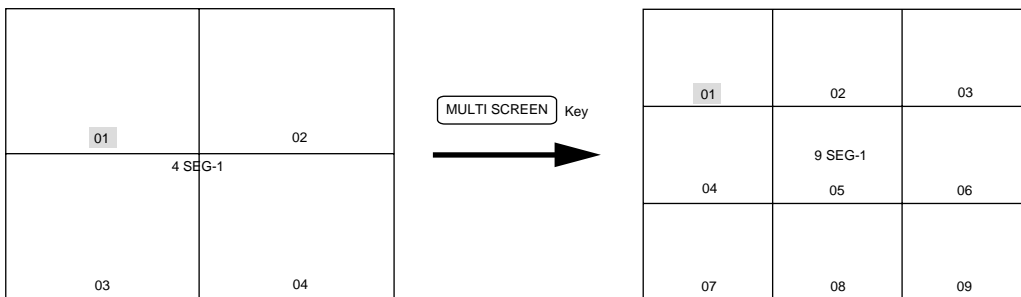
2. Press the 4-Segment Split Display key (), Multi-screen key or Group Selector key* to display the multi-screen (group) for which the camera arrangement is changed. (*C-MS161D only.)

Note: The operation used to display a multi-screen (group) is the same as used for ordinary screens. (Refer to p. 51.)



3. Move the cursor to the desired split-screen position with the cursor control keys (   ).

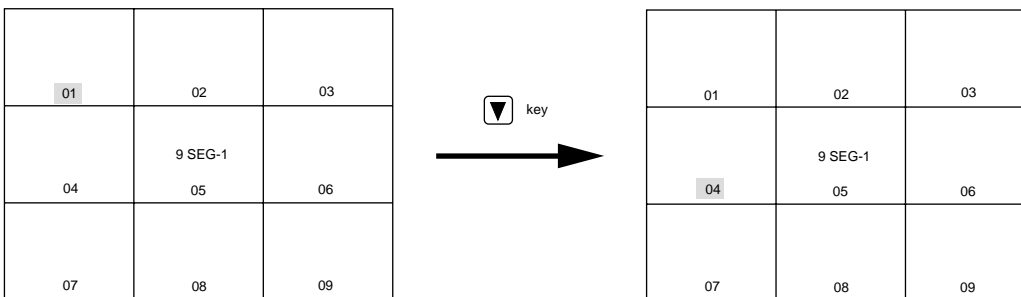

4. Press the Camera Selector key for the camera to be displayed.

The split-screen section indicated by the cursor is switched to the display of the selected camera number image.

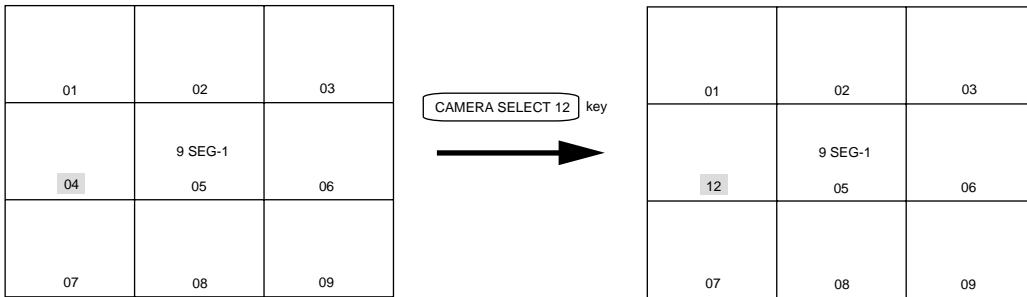

Note

- If the Camera selector key of the same number as the camera number indicated by the cursor is pressed, the split section is put in unselected mode as indicated by the background color, displaying the "-" indication instead of the camera number.
- In Camera mode, multiple same camera images can be arranged on the split sections. However, some connected cameras may not be displayed because the full number of split sections is limited (Example: Full display of 16 split sections of Groups 1 - 4 in the case of 4-segment split screen display by way of the C-MS161D).

5. Press the 4-Segment Split Display key () (or invalid key*) while holding down the Spot Selector key.

The Spot Selector key extinguishes and the 4-Segment Split Display key or Multi-Screen key changes from flashing to steady ON, enabling the operator to exit the Camera selection screen. (When an invalid key is used to exit, operation after exit follows that key.)

* Spot Selector key, Sequence key, Freeze key, Full-Screen key, Zoom key, Channel/Clock Display key, Menu key and Alarm Reset key

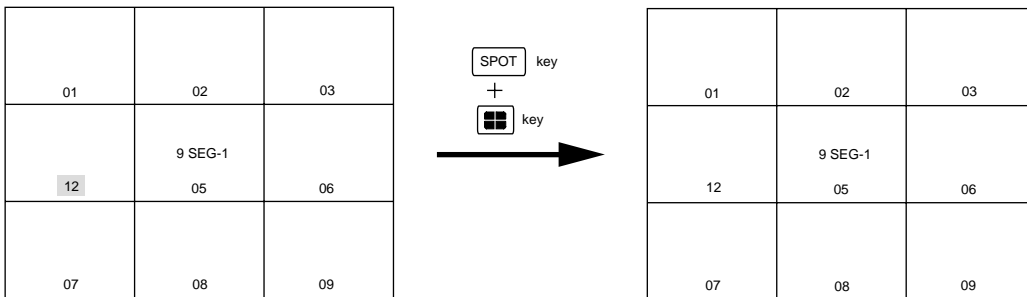

About setting interruption

- Because the screen can be switched by remote control during setting, the screen may suddenly change.
- When Video Loss alarm occurs during setting, the Multi-Switcher is put in Video Loss alarm mode. However, the current settings can still be maintained.
- When alarm is activated during setting, the setting operation is interrupted and replaced by alarm operation if the Alarm Hold function has been disabled. The current settings can still be maintained if the Alarm Hold function has been enabled.

15. VCR SETTINGS

Set the VCR's menu screen as follows:

15.1. Displaying the VCR's Menu Screen

1. Connect cameras, monitors, and VCRs to the Multi-Switcher.
2. Switch ON the power to these components.
3. Set the Multi-Switcher's Camera/VCR Mode Selector switch to the VCR position.
4. Press the VCR Menu/Search key.
VCR recorded screens are displayed on the monitor.

Note: Set the VCR's menu screen, referring to the VCR's instruction manual.

15.2. Setting the VCR's Display Characters

Some VCRs have their own clock. When using such VCRs with the Multi-Switcher, disable the VCR's date/time display function.

15.3. Setting the VCR's Alarm

When using Sensor alarm or Motion Detection alarm, set the VCR's alarm as follows:

- VCR alarm interval (DURATION*, ALARM REC DURATION*, etc.): Set to Alarm Ground*, MAN2* or MANUAL*.
 - VCR alarm recording mode: Set to SPEED*, ALARM REC MODE*, etc.
- * These indications differ depending on the type of VCR used.

15.4. Setting Alarm Recording for a VCR Not Currently in Operation

When using 2 VCRs to make continuous recordings, set so that alarm recording does not activate the VCR in pause mode.

Set the alarm recording function (ALARM READY*, EMERGENCY RECORDING*, etc.) of the VCR in pause mode to ON* or OFF*.

* These indications differ depending on the type of VCR being used.

15.5. Others

Quasi-vertical synchronization signals must be set for some types of VCRs. When such VCRs are connected and the recorded camera image is distorted during playback, set the quasi-vertical synchronization signal (QUASI V-SYNC) to OFF.

16. BASIC OPERATION MODE

16.1. Keys to use in operations

Shown below are the switches and keys to be used for operation. (The figure shows the C-MS161D.)

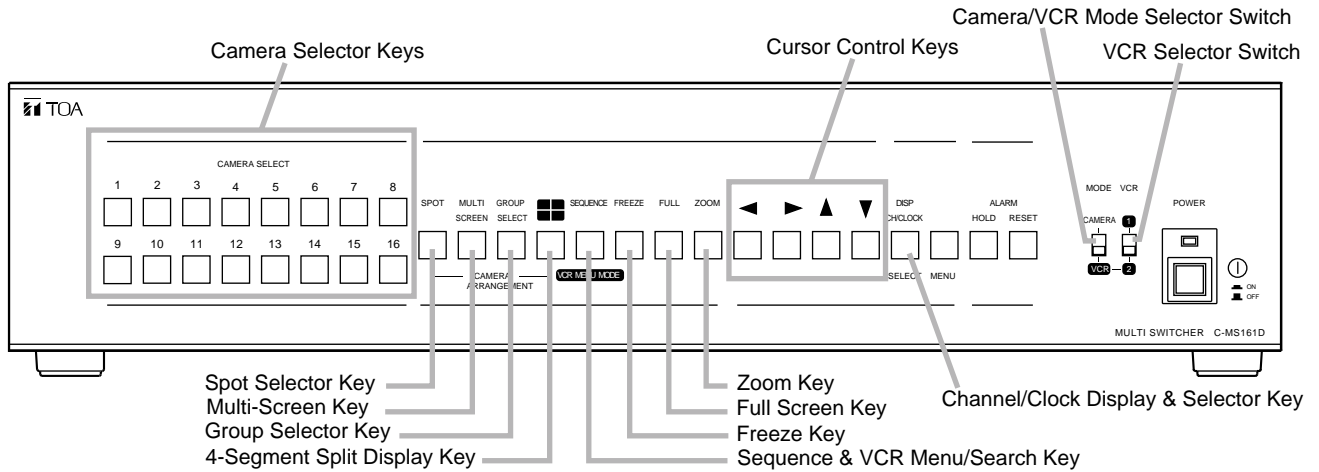

16.2. Camera Mode and VCR Mode

16.2.1 Camera/VCR Mode Selection

When monitoring real-time camera images, set the Camera/VCR Mode Selector switch to the CAMERA position. To play back recorded video images, set the switch to the VCR position.

16.2.2. Operations for Screen Display Selection

- Unless specifically stated, operate the key in the same manner regardless of whether it is set to Camera or VCR position.
- For the items marked as "Camera mode" or "VCR mode," key operations differ for each mode.
- Items marked as "Camera mode only" refer to functions that can only be operated in the specified mode.

16.3. Basic Multi-Switcher Operations

16.3.1. Camera Image Viewing

To monitor camera images, set the Camera/VCR Mode Selector switch to the CAMERA position.

Tips

On multi-screen (4-, 9-, 10- and 16-segment* split-screen) displays, since images are intermittently displayed, their movements are jerky.

* C-MS161D only

16.3.2. VCR Recording

- The Camera/VCR Mode Selector switch may be set to either position, CAMERA or VCR. (It is recommended that the switch be set to the CAMERA position in normal use.)
- Recording is started when VCR's recording button is pressed.

Note

- VCR 1 and VCR 2 cannot be simultaneously used for recording.
- When two VCRs are used, recording can be made with one VCR even while the other VCR is playing back recorded images. To accomplish this, set the Camera/VCR Mode Selector switch to the VCR position.

16.3.3. VCR Playback

- To play back recorded images, set the Camera/VCR Mode Selector switch to the VCR position.
- Select either VCR 1 or 2 with the VCR Selector switch, then press the VCR's playback button.
- To view fast forward/rewind playback images, press the VCR's fast forward or rewind button while holding down the Multi-Switcher's VCR Menu/Search key.

Note

The screen is not normally renewed if fast forward/rewind playback is performed without pressing the VCR Menu/Search key.

17. CHANGING THE SCREEN DISPLAY MODE

Operations of switching screen displays during real-time camera monitoring and VCR image playback are identical.

17.1. Viewing Camera Images on the Full Screen

17.1.1. Full-Screen Display

Pressing the Camera Selector key (1 – 16) displays the selected camera image on the monitor in full-screen display.

17.1.2. Sequential Display (Camera mode only)

1. Press the Sequence key.

Camera images are automatically switched and displayed in sequential order as shown below:

Note: Cameras set to be skipped on the Sequence skip setting screen (refer to p. 40) are not displayed.

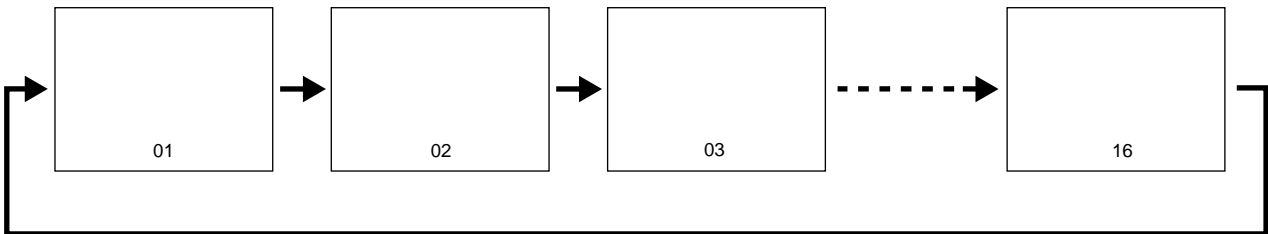

- If the Sequence key is pressed again, the sequential display stops at the currently-displayed screen.
- Dwell time (sequential switching interval) can be set for 1 – 99 seconds in 1 second units. (Refer to p. 35; Sequence Dwell Time, on the Option 1 setting screen.)

2. Press any key (such as the 4-Segment Split Display key ) other than the Sequence key.

Sequential displays are interrupted, and changed to the screen designated by the key.

Note: Even if the Freeze key is pressed during sequential switching operation, the display does not change to the freeze-frame screen.

17.2. Viewing Camera Images on the 4-Segment Split Screen

17.2.1. 4-Segment Split-Screen Displays

1. Press the 4-Segment Split Display key ().

Camera images are displayed on the monitor in 4-segment split-screen displays.

2. Press the 4-Segment Split Display key () again or the Group Selector key*.

The camera group displayed on the 4-segment split screen is switched to a different camera group.

* C-MS161D only

17.2.2. 4-Segment Split-Screen Sequential Displays (Camera Mode Only)

When the Multi-Switcher is in Camera mode, 4-, 9-, 10- or 16-segment* split-screen displays can be switched to the 4-segment split-screen sequential display.

* C-MS161D only

1. Press the Sequence key.

Camera groups are automatically displayed in sequential order on the 4-segment split screen as shown below.

C-MS161D

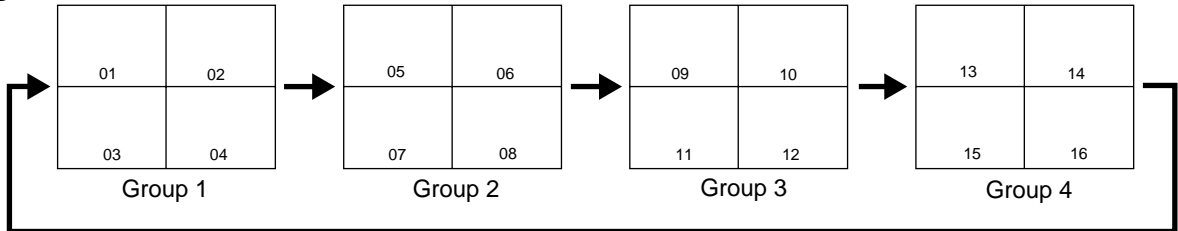

C-MS91D

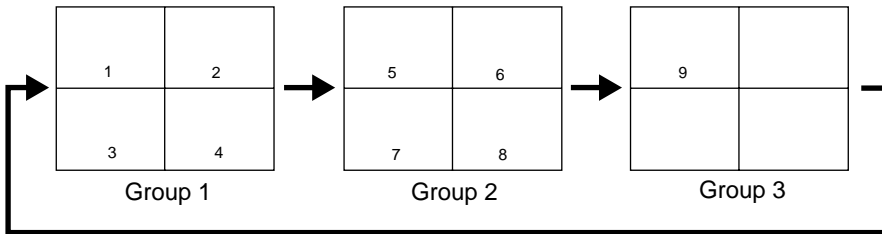

- If the Sequence key is pressed again, the sequential display stops at the currently-displayed screen.
- Dwell time (sequential switching interval) can be set for 1 – 99 seconds in 1 second units. (Refer to p. 35; Dwell Time, on the Option 1 setting screen.)
- To display Group 3 (factory-preset to Camera 9) for the C-MS91D, perform the setting on the Menu screen. (Refer to p. 38; 4-Split Display Group 3, on the Other Settings screen.)

2. Press any key (such as the 4-Segment Split Display key ) other than the Sequence key.

Sequential displays are interrupted, and switched over to the screen designated by the key.

Note: Even if the Freeze key is pressed during sequential switching operation, the display is not switched over to the freeze-frame screen.

17.3. Viewing Camera Images in Multiple-Screen Displays

The multi-screen display mode cycles through 9-, 10- and 16-segment* split-screen displays with each depression of the Multi-Screen key.

* C-MS161D only

Note:

- The 10-segment split-screen display is disabled during VCR playback (VCR mode).
- When the C-MS161D is in 9- or 10-segment split-screen display mode, camera groups can be changed by pressing the Group Selector key.

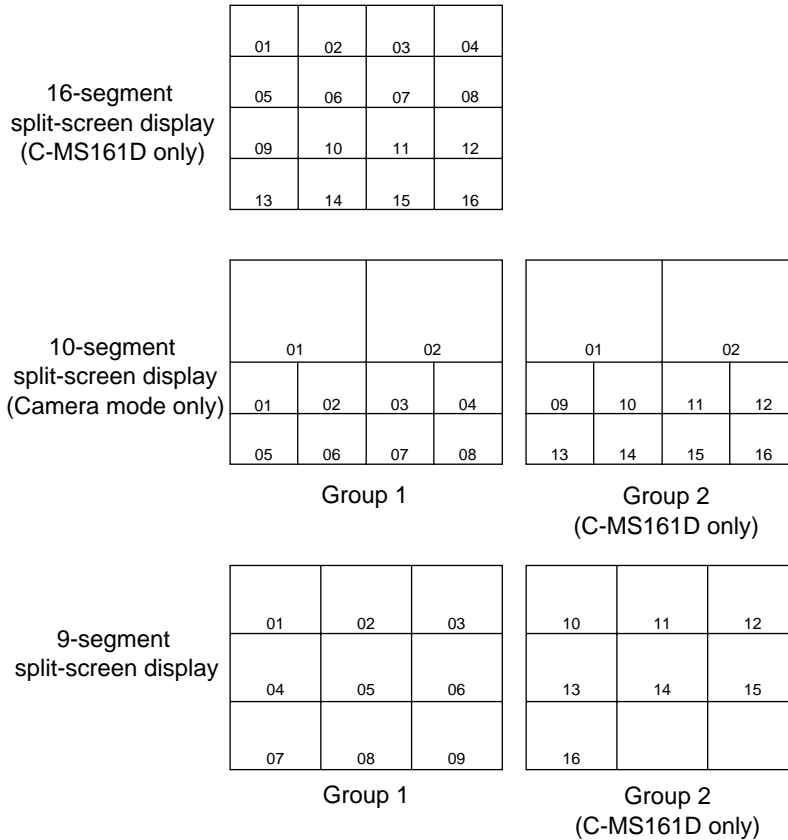

17.4. Viewing Camera Images in Zoom Displays (Electronic Zoom)

1. Select the camera to be zoomed, then press the Zoom key.

The center of the screen of the selected camera image is displayed on the 2x zoomed screen.

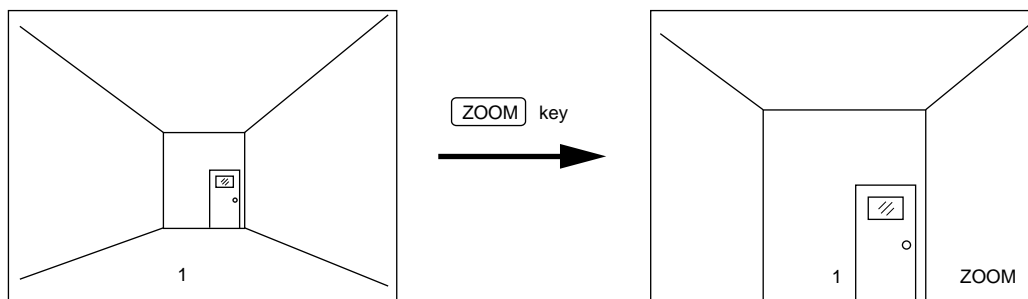

2. Use the Cursor Shift keys (◀▶▲▼) to move the zoom position.

- Simultaneously pressing the Left and Right Shift keys automatically moves the zoom position horizontally (Auto-Pan). To cancel Auto-Pan, press any cursor shift key (◀▶▲▼).
- Simultaneously pressing the Up and Down Shift keys automatically moves the zoom position vertically (Auto-Tilt). To cancel Auto-Tilt, press any cursor shift key (◀▶▲▼).

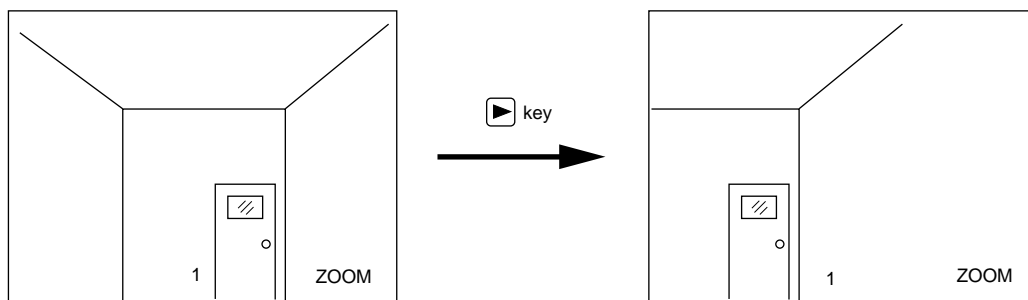

3. To reset zoom, press the Full Screen key.

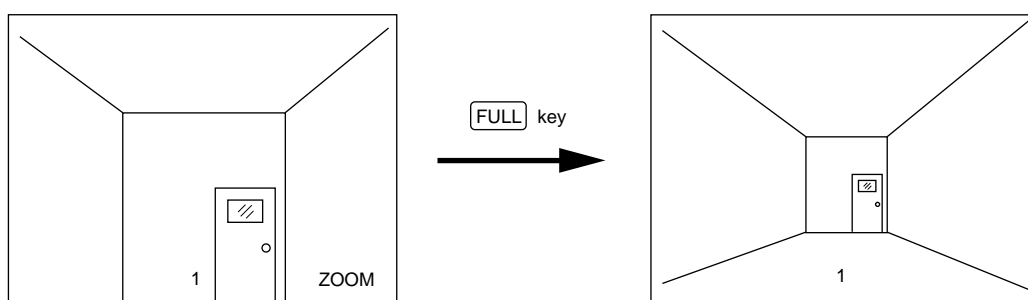

17.5. Displaying the Freeze Full Screen or Freeze Zoom Screen

- Pressing the Freeze key during full-screen or zoom display freezes the display. The title indication changes to a flashing "FREEZE" indication during the freeze screen display.
- To reset the freeze screen, press the Freeze key while the freeze screen is being displayed. (Freeze-frame mode can also be cancelled by pressing any key other than the Full Screen key, Zoom key, and Cursor Shift keys (◀▶▲▼).)
- The display mode can be switched between the full screen and zoom screen, and the zoom position can also be moved during freeze display.

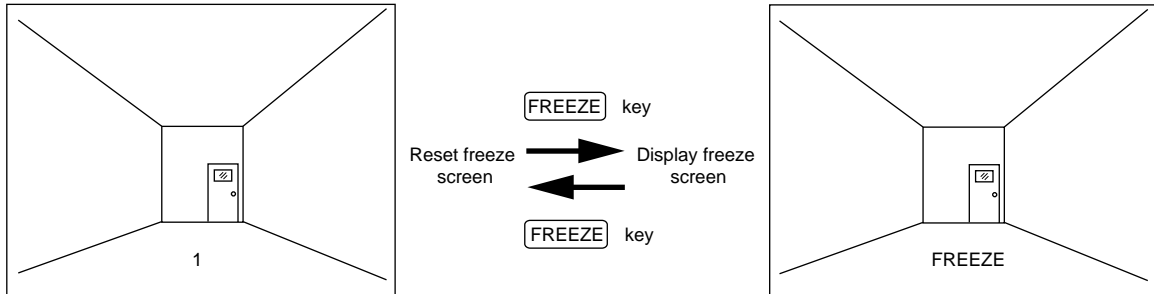

17.6. Displaying the Freeze Screen During Multi-Screen Display

1. Press the Freeze key during multi-screen (4-, 9-, 10*- or 16-segment split-screen) display. The Freeze key flashes, switching the screen to freeze-frame mode.
 - * Can only be used while in Camera mode.

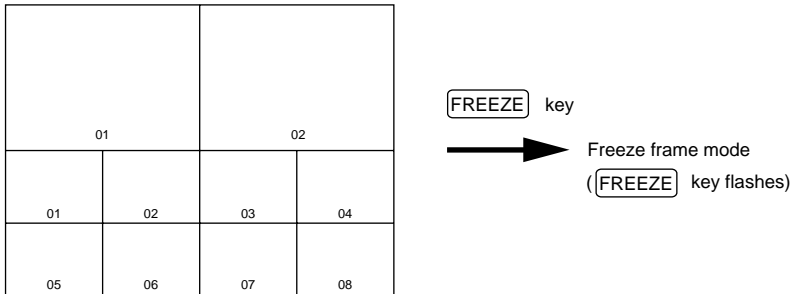

2. Press the Camera Selector key to select the camera to freeze. The title of the freeze-screen camera changes to a flashing "FREEZE" or "F" indication.

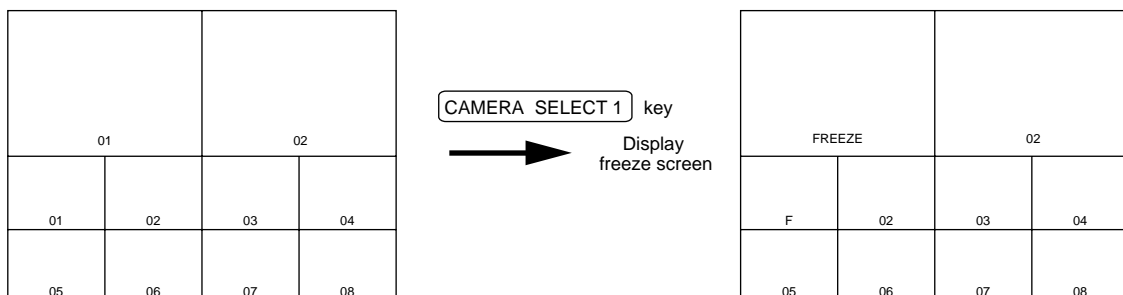

3. Reset the freeze screen.

3-1. Press the Camera Selector key for the freeze-screen camera. The freeze screen is reset.

3-2. Press the Freeze key. All freeze camera screens are reset.

(Pressing any key other than the Camera Selector key also resets all freeze camera screens.)

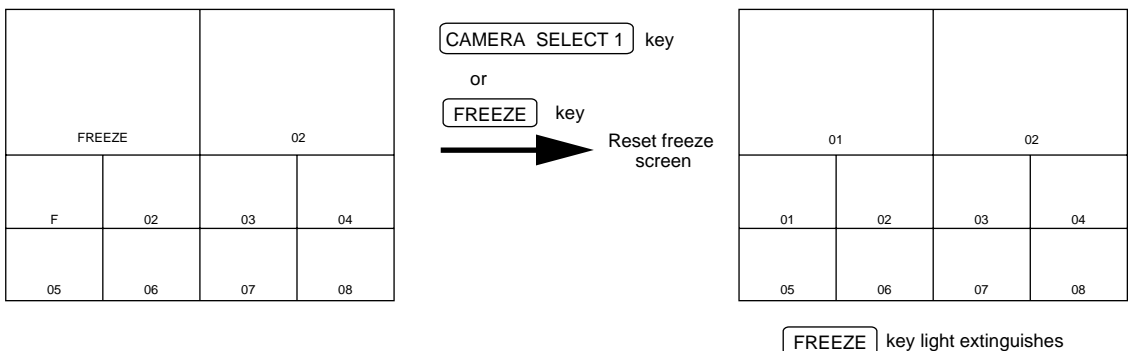

17.7. Spot Output Operations

17.7.1 Spot Output Display Screen

- If Monitor Output 2 is set as Spot Output, camera images different from those of Monitor Output 1 can be displayed on the full screen or in sequential order. (Refer to p. 38; Monitor Output 2, on the Other Settings screen.)
- The Spot Output sequential switching interval is set on the menu screen. (Refer to p. 35; Dwell Time (Spot Output), on the Option 1 setting screen.)

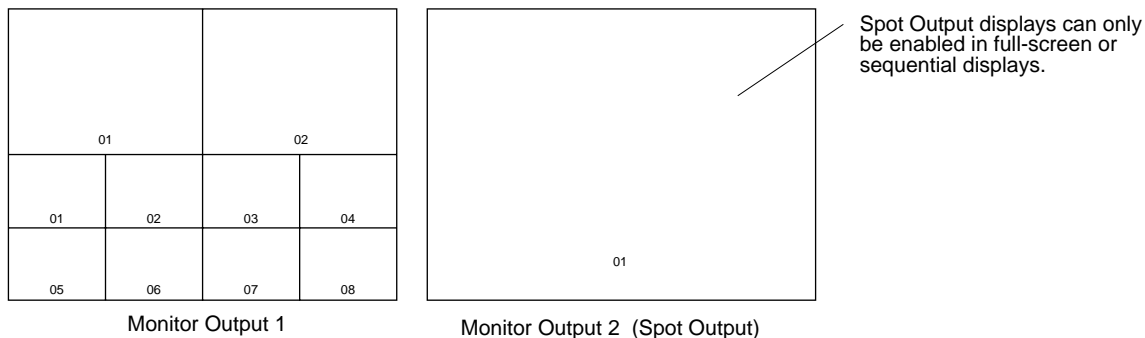

17.7.2. Spot Output Switching

1. Press the Spot Selector key to switch the Spot Output.

The Spot Selector key flashes, making it possible to select Spot Output.

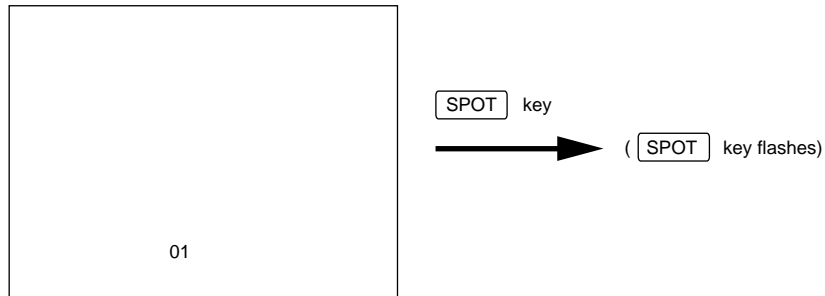

2. Press the Camera Selector key or Sequence key.

The Spot output screen is switched.

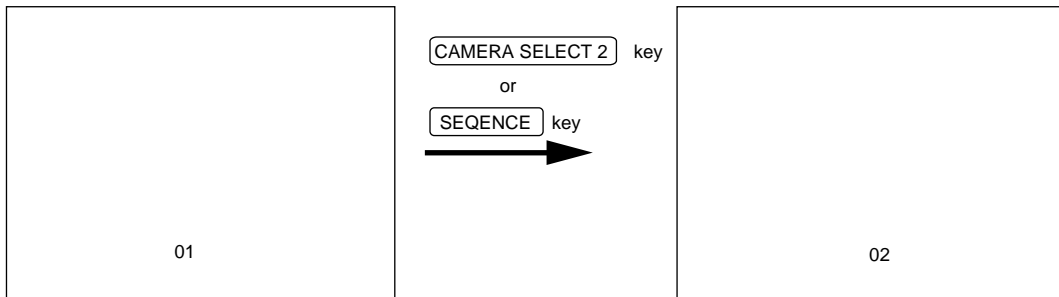

3. Press the Spot Selector key (Sequence key or any key other than the Camera Selector key).

The light of the Spot Selector key extinguishes, allowing the Monitor Output 1 screen to be selected. (When any key other than the Spot Selector key is used to exit the switching mode, screen operations after exit follow that key.)

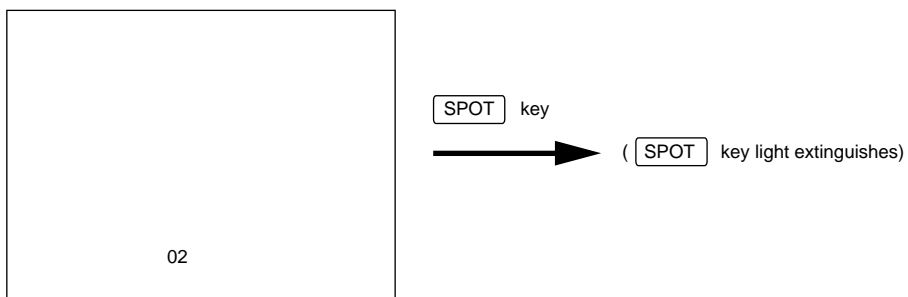

17.8. Camera Number and Date/Time Displays

Note: Camera numbers and time/date cannot be displayed on the Spot Output monitor.

[Camera Mode]

- Press the Channel/Clock Display key when the camera title is displayed.
The camera title indication changes to the camera number indication*, which reverts to the title indication after an interval of 10 seconds.
* When the camera number is displayed in 9- or 16-segment split-screen displays, the indication does not change, even though the Channel/Clock Display key is pressed.
- Press the Channel/Clock Display key again when the camera number is displayed on the screen. Date and time are displayed on the screen.
- Press the Channel/Clock Display again when the date and time are displayed. The indication reverts to the title indication.
(The display also automatically reverts to the title indication 10 seconds after the date and time are displayed.)

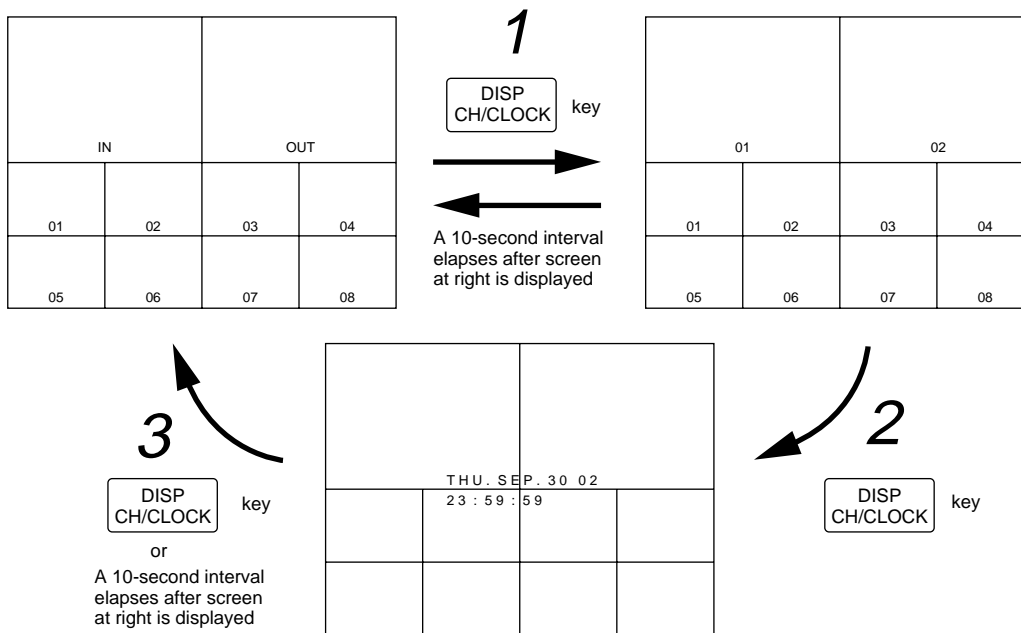

[VCR Mode]

- Date and time are displayed when the Channel/Clock Display key is pressed while in VCR mode. The display automatically reverts to the original indication after an interval of 10 seconds. (The display also automatically reverts to the original indication when the Channel/Clock Display key is pressed again.)

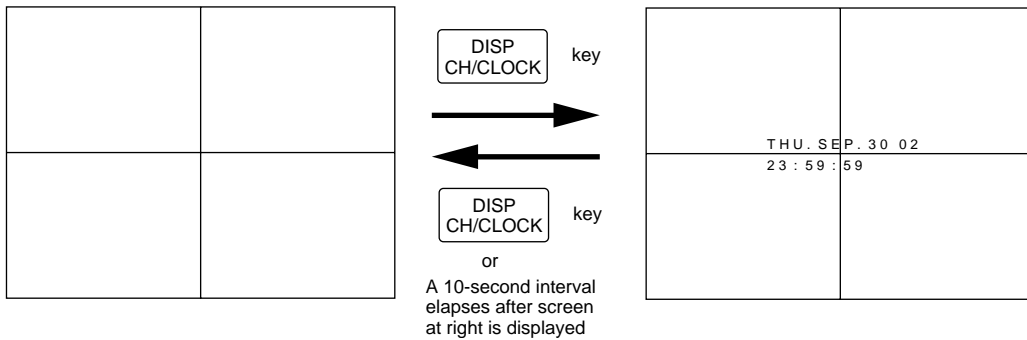

Note: Titles recorded on a VCR are also displayed on the screen during actual VCR playback.

18. ALARM FUNCTIONS

18.1. Sensor Alarm

18.1.1. Keys used in operations

The figure shows the C-MS161D.

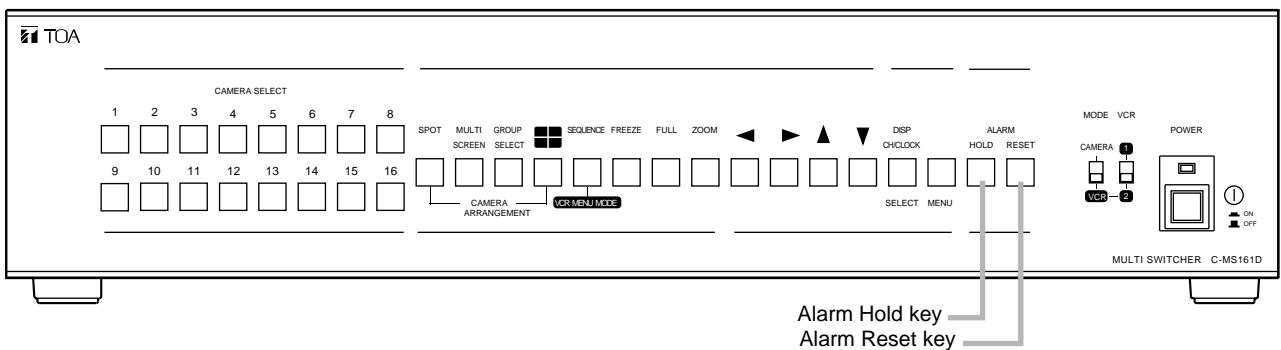

18.1.2. Sensor Alarm Function

The Multi-Switcher is equipped with a single-channel alarm input terminal for each camera. These terminals are connected to such devices as door switches or infrared sensors to activate the sensor alarm function. When sensors are triggered, the Sensor Alarm function provides a warning by displaying an on-screen alarm indication as well as by sounding a buzzer, and switches the connected VCR to alarm recording mode for making video recordings. The Multi-Switcher also has an alarm output terminal that operates upon receiving an alarm signal from any channel. Utilizing this output, an external buzzer can be sounded when alarm is triggered. (Refer to p. 66; Alarm Input/Output Terminals.)

Note: Sensor alarm operation becomes active approximately 15 seconds after power is switched ON.

18.1.3. Sensor Alarm Activation

The system switches to Sensor Alarm mode if the sensor corresponding to a camera is triggered and the alarm input terminal is short- or open-circuited.

Note: Set the Menu screen Sensor Alarm Function to OFF when the Sensor Alarm function is not used. (For this setting, refer to p. 34; Sensor Alarm on the Alarm setting screen.)

18.1.4. Sensor Alarm-Activated Operations

Sensor Alarm provides the following alarm operations:

1. A buzzer is sounded, and the Alarm Reset key flashes red. (To disable a buzzer, refer to p. 37; Buzzer on the Buzzer/Character Display setting screen.)
2. The alarm-activated camera is displayed on the full screen.
3. The flashing "ALARM" indication is displayed on the monitor.
4. VCR operation is switched from time lapse mode (recording mode "12" or greater) to alarm recording mode in order to record the alarm-activated camera image.
5. When Monitor Output 2 is designated as Spot Output, selected camera images are provided from Spot Output regardless of alarm status.

Note

- Enabling the Alarm Hold function permits the monitor output image to be manually changed even during Sensor Alarm operation.
- If the detection function is set to "Alarm (AND)" on the Menu screen, the above alarm operations occur only when simultaneous Sensor alarm and Motion Detection alarm signal inputs are received. (Refer to p. 62; Motion Detection Alarm.)
- When the Sensor Alarm is activated during VCR playback, the monitor screen automatically switches from the VCR playback to the alarm-activated camera image display.

Tips

- To disable the Sensor Alarm display during VCR playback, set the Multi-Switcher to Alarm Hold. (Refer to p. 61; Alarm Hold.)

Note

- When the Alarm Hold function is enabled while in VCR mode, the Alarm Hold status is maintained even if the VCR mode is switched to Camera mode.

18.1.5. Sensor Alarm Reset

The method used to reset the alarm differs depending on the sensor alarm activation method (refer to p. 61; Sensor Alarm Interval).

[Edge-type activation]

Alarm is reset when a predetermined alarm time interval expires or when the Alarm Reset key is pressed.

[Level-type activation]

Short the Alarm input terminal to the ground terminal or open-circuit the Alarm input terminal from the ground terminal.

Note

- The Sensor Alarm cannot be reset with the Alarm Reset key.

Tips

When the Sensor Alarm is reset, the previous screen that was displayed just before the Sensor Alarm was activated is displayed. Exception: If a camera image connected to Monitor Output 1* is switched to another screen display during alarm operation, the screen display is maintained even after Sensor Alarm operation is reset. (Previous screen is not restored.)

* Monitor Output 2 operates in like manner if set to "Same as Monitor Output 1."

18.1.6. Sensor Alarm Interval

Two different methods are used to activate the Sensor Alarm: "Edge-type" and "Level-type."
 (For the activation method settings, refer to p. 34; Alarm Signal, on the Alarm setting screen.)

[Edge-type]

The Sensor alarm operates for a duration equal to the alarm interval set on the Menu screen. (For alarm interval settings, refer to p. 34; Alarm Time, on the Alarm setting screen.)

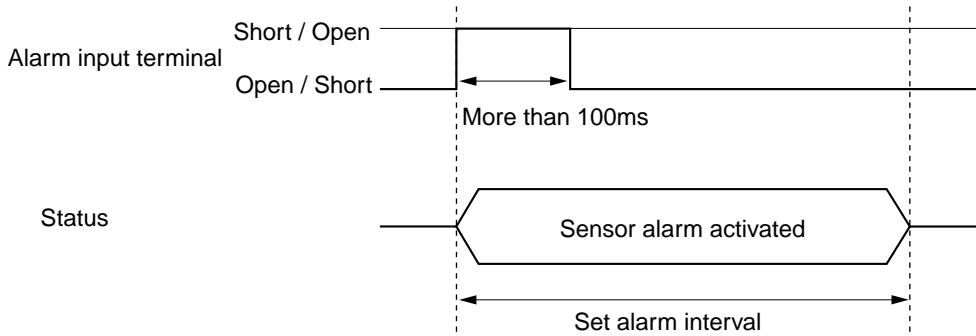

[Level-type]

The Sensor alarm continues to operate while the alarm input terminal is shorted or open.

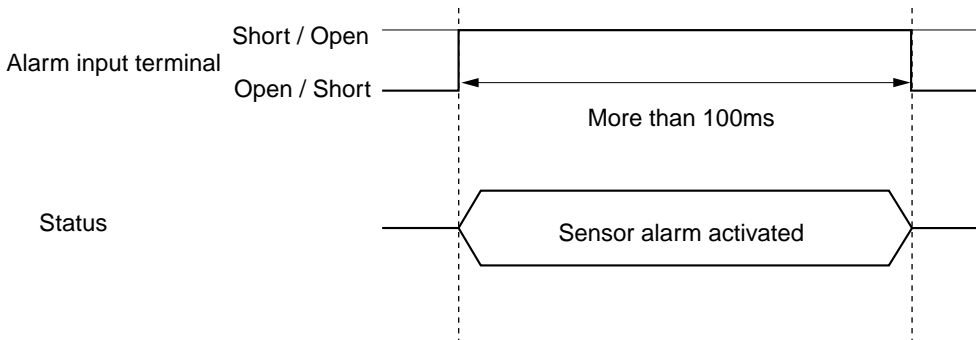

18.1.7. Alarm Hold

This function is useful when you cannot view the selected camera output because on-screen camera scenes are frequently switched on account of frequent sensor alarm inputs .

[To enable the alarm hold function...]

Press the alarm hold key. (The alarm hold key will light.)

Tips: It is possible to always maintain alarm hold mode without pressing the alarm hold key. (For the setting, refer to p. 32 "ALARM HOLD" in the section "Recording/Alarm Setting Screen.")

[To reset the alarm hold function...]

Press the alarm hold key that remains lit. The light of the alarm hold key will then be extinguished.

[If sensor alarms are triggered while in alarm hold mode...]

- The lights of both the alarm reset key and alarm hold key flash, and the indication of "AL HOLD" is displayed on the monitor.
- Currently-displayed camera images are not switched. However, the alarmed camera outputs are recorded on a VCR.
- To switch the currently-displayed camera image to the alarmed camera image, press the alarm hold key to reset alarm hold mode.

18.1.8. Simultaneous Multiple Alarm Operations

Operations when multiple alarms are simultaneously triggered can be selected from three types of alarm functions: LAST, SEQ, and ALL. (For the setting methods, refer to p. 33; Alarm Function, on the Alarm setting screen.)

Note: Recorded images cannot be correctly played back if the Alarm function used for recording differs from that used for playback. Be sure to use the same Alarm function for both recording and playback.

The following table shows operations of each Alarm function:

Operation Alarm Function	Sensor Alarm (Camera Mode)		VCR Playback Alarm (VCR mode)
	Monitor Display	VCR Recording	
LAST	Displays the last camera image.	Records the last camera image.	When the section recorded in Sensor Alarm mode is played back, a buzzer sounds and the alarm-activated camera is automatically displayed on the full screen, while the "ALARM" indication is displayed on the lower left of the screen.
SEQ	Displays alarm-activated cameras in sequential order. (Dwell time is fixed for 1 second.)	Records all alarm-activated cameras. (Does not depend on the recording pattern.)	A buzzer sounds when the section recorded in Sensor Alarm mode is played back.
ALL	Displays alarm-activated cameras in sequential order. (Dwell time is fixed for 1 second.)	Records all connected cameras.	A buzzer sounds when the section recorded in Sensor Alarm mode is played back.

Note: When an alarm input to the Video Loss camera is received while the Alarm function is set to SEQ, the Alarm function is automatically changed to ALL operation.

18.2. Motion Detection Alarm

The Motion Detection function can be handled as an alarm identical to the Sensor alarm. Operation when the alarm is activated, the method to set Alarm Hold, and operation when there are multiple alarm inputs are the same as used for Sensor alarm.

Note: The Motion Detection function requires approx. 15 seconds to commence operation after the power is switched ON.

18.2.1. Motion Detection Function Settings

- If the Motion Detection function is set for "ALARM (OR)," alarm operation is started when movement is detected or there is a Sensor alarm signal input.
- If the Motion Detection function is set for "ALARM (AND)," alarm operation is started when both the motion detection and Sensor alarm signal input occur simultaneously.

18.2.2. Motion Detection Alarm Reset

The reset method differs depending on the alarm activation method (refer to p. 61; Sensor Alarm Interval.)

[Edge-type activation]

Pressing the Alarm reset key resets the Motion Detection alarm.

[Level-type activation]

The Motion Detection alarm automatically resets after the Motion Detection interval plus 5 seconds elapses. The alarm cannot be reset during this period of time.

Tips: When the Motion detection alarm is reset, the display reverts to the screen last displayed before it was switched to the Motion Detection alarm screen. However, if the Monitor Output 1* image is switched to another screen display during alarm operation, the screen display is maintained even after Motion Detection alarm reset. (The display does not revert to the previous screen.)

* If Monitor Output 2 has been set to "Same as monitor output," Monitor Output 2 also operates in like manner.

18.2.3. Motion Detection Alarm Interval

The alarm interval is the motion detection time plus 5 seconds, as shown in the following figure:

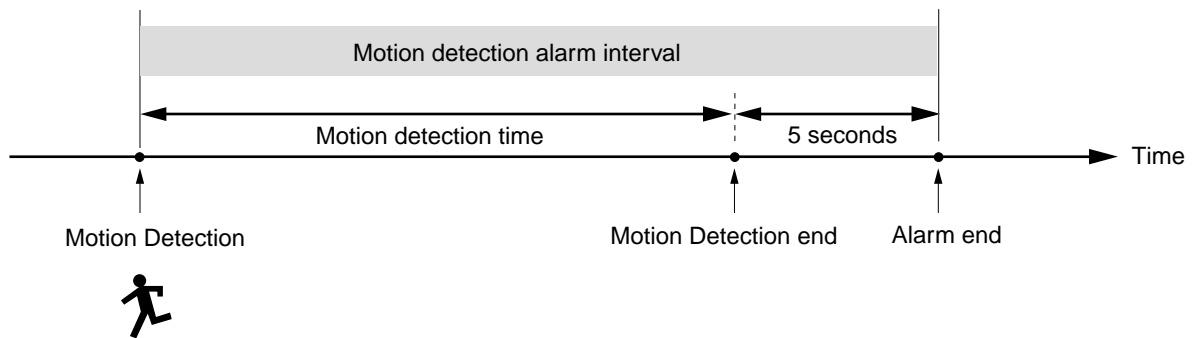

18.2.4. Alarm Operating Interval

[Motion Detection function set to "ALARM (OR)"]

Alarm activates when a movement in camera image is detected or Sensor alarm input is received.

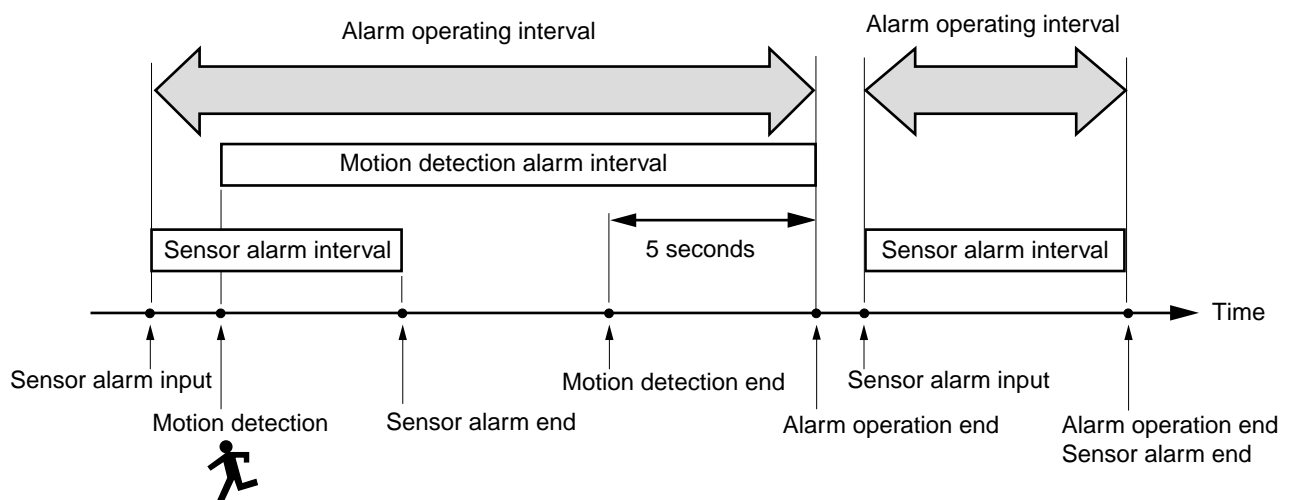

[Motion Detection function set to "ALARM (AND)"]

The Alarm is operated for durations of concurrent occurrences of both the motion detection and Sensor alarm input, plus 5 seconds.

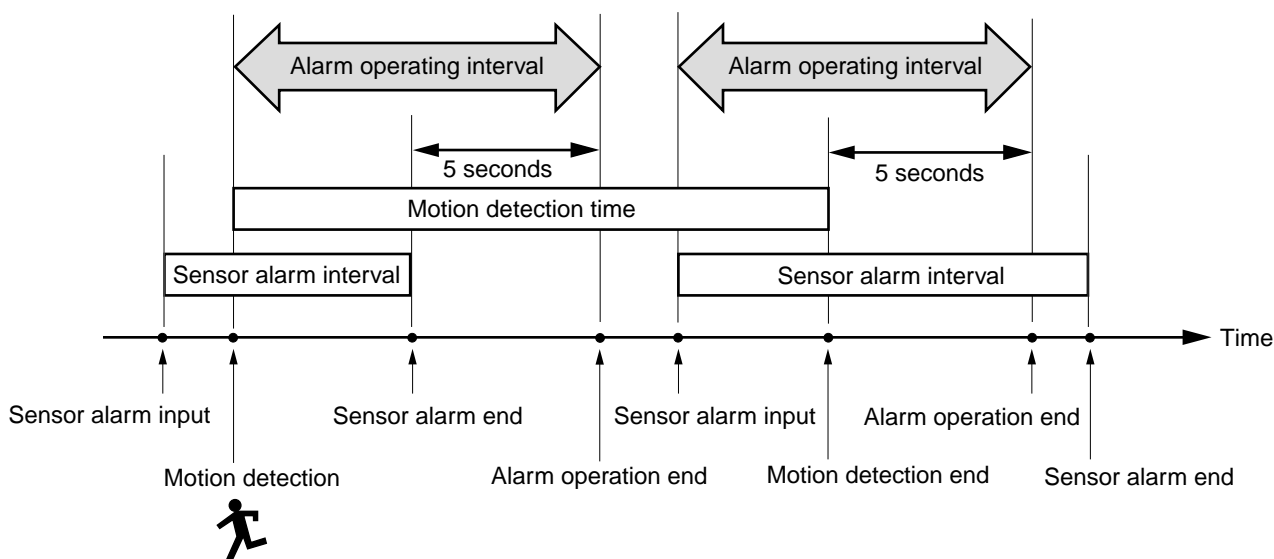

Note: If the sensor's output is a one-shot output (Edge type), set the Multi-Switcher's alarm signal to "Edge."
(Refer to p. 34; Alarm Signal, on the Alarm setting screen.)

18.3. VCR Playback Alarm

If the tape portion recorded in the Sensor alarm or Motion Detection alarm mode is played back, a warning is made by sounding the buzzer and displaying an on-screen alarm indication.

18.3.1. When the VCR Playback Alarm is activated

- The buzzer sounds and the Alarm Reset key flashes.

Note: Pressing the Alarm Reset key during VCR playback alarm temporarily stops the alarm buzzer.

- The "ALARM" indication is displayed for the alarm-activated camera.
- When the freeze screen is displayed during VCR playback, the screen stands still but the VCR continues playback. The freeze screen is reset if the section recorded in Sensor alarm or Motion Detection alarm mode is played back.

18.3.2. VCR Playback Alarm Reset

The playback alarm is reset when the VCR is stopped or when the tape section other than those recorded in Sensor alarm or Motion Detection alarm modes is played back.

18.4. Video Loss Alarm

The Video Loss alarm provides notice of camera failures, such as might occur if the camera cable were cut or the camera power supply switched off. This function is activated when the signal transmission from the connected camera is interrupted.

18.4.1. If the Video Loss alarm is triggered, the most recent Video Loss alarm-activated camera number is displayed on the monitor and VCR recorded images. The Video Loss camera number is displayed on the right side of the "VL" indication, and the Alarm Reset key flashes.

18.4.2. To reset the Video Loss alarm, press the Alarm Reset key. Resetting the Video Loss alarm-activated camera alone does not reset the Video Loss alarm.

Note: Switch OFF the Video Loss alarm function on the Menu setting screen when not using the function. (For more information on setting methods, refer to p. 33; Video Loss Alarm on the Alarm Setting screen.)

18.5. Alarm Information

The Multi-Switcher has an alarm data function which stores the date and time of the occurrences of Sensor alarm, Motion Detection alarm and Video Loss alarm activation, as well as the alarm-activated camera numbers.

18.5.1. To display the stored date, time and camera number, select Alarm Information from the user menu or total menu screen. (Refer to p. 26 and p. 41; Alarm Information.)

18.5.2. Alarm Information Screen Example

- Up to 8 lines of alarm data can be simultaneously displayed, numbered in chronological order. (Left column of the screen at right.)
- The Video Loss alarm camera number is displayed together with the suffix "L" When the Sensor alarm or Motion Detection alarm is triggered, only the alarm-activated camera number is displayed.

Tips: The Sensor alarm and Motion Detection alarm are indistinguishable from each other as displayed on the Alarm Information screen.

- When over 64 Sensor, Motion Detection and Video Loss alarms have been logged, the oldest data entries are deleted in chronological order.
- Older data entries can be displayed with the Down (▼) key, and newer entries displayed with the Up (▲) key.

Note: Pressing the Alarm Reset key during the Alarm Information display deletes all alarm data.

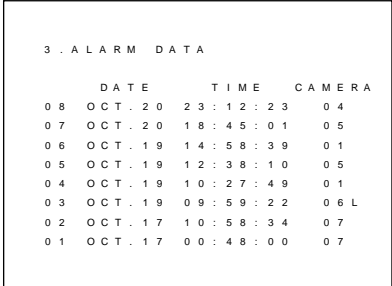

3 . ALARM DATA			
	DATE	TIME	CAMERA
08	OCT. 20	23 : 12 : 23	04
07	OCT. 20	18 : 45 : 01	05
06	OCT. 19	14 : 58 : 39	01
05	OCT. 19	12 : 38 : 10	05
04	OCT. 19	10 : 27 : 49	01
03	OCT. 19	09 : 59 : 22	06 L
02	OCT. 17	10 : 58 : 34	07
01	OCT. 17	00 : 48 : 00	07

18.6. Alarm Input/Output Terminals

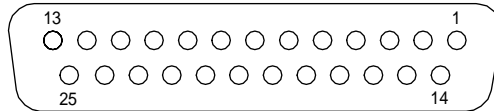

Pin No.	Function	Pin No.	Function
1	GND	14	Alarm reset output
2	Camera 1 sensor input	15	Alarm output
3	Camera 2 sensor input	16	Video loss output
4	Camera 3 sensor input	17	Alarm hold output
5	Camera 4 sensor input	18	Motion detection output
6	GND	19	Camera 10 sensor input*
7	Camera 5 sensor input	20	Camera 11 sensor input*
8	Camera 6 sensor input	21	Camera 12 sensor input*
9	GND	22	Camera 13 sensor input*
10	Camera 7 sensor input	23	Camera 14 sensor input*
11	Camera 8 sensor input	24	Camera 15 sensor input*
12	Camera 9 sensor input	25	Camera 16 sensor input*
13	GND		

*C-MS161D only

Alarm Input

- The ALARM input number is the input terminal number that corresponds to the video input number.
- Shorting the Alarm input to the ground terminal or opening the input from the ground terminal activates the Sensor alarm or Motion Detection alarm.
- A 5V DC voltage is applied to the Alarm input terminal when open-circuited, and a current of up to 5mA flows when shorted. This terminal must be shorted or opened for longer than 100 ms.

Alarm Output

- The Alarm output terminal is shorted to the ground terminal during alarm operation.
- The Video Loss alarm output terminal is shorted to the ground terminal during Video Loss alarm operation.
- The Sensor/Video Loss alarm output terminal is an NPN open collector output that passes a current of up to 20 V/20 mA.

Note: If the Motion detection function is set to "ALARM (AND)" or "ALARM (OR)," an alarm is activated when a movement or change in the camera image is detected.

Alarm Hold Output

- Alarm Hold output remains shorted to the ground terminal while the Multi-Switcher is in Alarm Hold mode.
- The Alarm Hold output terminal is an NPN open collector output that passes a current of up to 20 V/20 mA.

Alarm Reset Output

- The Alarm Hold output is shorted to the ground terminal when the Alarm mode is reset.
- The Alarm Reset output is an NPN open collector output that passes a current of up to 20 V/20 mA.

Motion Detection Output

- When Motion Detection is set for any other condition than OFF, if a change in the camera image is detected, the Motion Detection output is shorted to the ground terminal.
- The Motion detection output is an NPN open collector output that passes a current of up to 20 V/20 mA.

19.REMOTE CONTROL FUNCTION

19.1. About the Remote Control Function

The Multi-Switcher features two functions that allow it to be controlled from remote locations.

1. Remote control using the dedicated remote controller
 - 1-1. C-RM100 (used in combination with the C-SC100)
Using the dedicated remote controller, operations of such functions as camera selection, combination cameras, pan/tilt heads and zoom lenses can be comprehensively controlled. (Refer to p. 86 for connection examples.)
 - 1-2. C-RM500
Using the dedicated remote controller, operations of such functions as camera selection, combination cameras, pan/tilt heads and zoom lenses can be comprehensively controlled. (Refer to p. 87 for connection examples.)
2. Remote control by way of the remote input/output terminals
The Multi-Switcher's front panel-mounted keys can be remotely operated by connected external equipment. (For the setting method, refer to p. 39; Front Panel Switch Operation on the Remote Control Setting screen.)

Note: External operation panels of standard specifications are not available.

19.2. Remote Controller Usage

- The C-RM100 and C-RM500 Remote Controllers allow the Multi-Switcher to be operated from remote locations with the same range of operation as when controlled directly from its front panel. The Multi-Switcher can also be remotely operated even when its front panel operation keys are locked (p. 79).
- The Remote Controllers can perform Multi-Switcher camera selection, sequential display, multi-screen display (4-, 9-, 10-*, and 16-segment split screen displays), freeze screen display, group selection, and camera channel/clock display.
 - * Camera mode only.

Note: There are some functions which cannot be operated by the Remote Controllers or are restricted in operation. Such functions must be performed by way of the Multi-Switcher's front panel.

Inoperable Functions

- Zoom display (electronic zoom)
- Camera/VCR mode switching
- Spot output selection
- Video Loss alarm reset
- Clock display
- Menu screen setting
- Camera arrangement
- Key lock

Restricted Functions

- Freeze screen in 10-segment split-screen display.
The freeze screen can only be displayed in the lower portion (8 segments) of the 10-segment split-screen.
- Simultaneous operation by a Remote Controller and other connected equipment results in the most recent operation taking precedence. However, in regards to manual operation of the same camera's pan, tilt and zoom lens, the first operation takes precedence.

- The following components can be connected by way of the dedicated Remote Controller lines:

Equipment	No. of Usable Units
C-RM100 Dedicated Remote Controller	1 – 2 units
C-RM500 Dedicated Remote Controller	1 – 2 units
C-MS91D/C-MS161D Multi-Switcher	0 – 1 unit
C-SC100 Single-Channel Controller	0 – 8 units

Note: When using two Remote Controllers, if the power to the "Master" Remote Controller is switched OFF, the "Slave" Remote Controller is also rendered inoperative.

- If a Remote Controller is used in the system, refer to the following table for the settings of each component. For other settings, refer to each component's instruction manual.

Equipment	Setting Item	Contents
C-RM100 Remote Controller	Operation Mode	Master : Select this when a single Remote Controller is used. Slave : Designate one unit as Slave when two Remote Controllers are used.
	Switcher Settings	16 Channels : Select when using the C-MS161D Multi-Switcher. 9 Channels A : Select when using the C-MS91D Multi-Switcher and when the Multi-Switcher's "4-SEG GROUP 3" setting is set to OFF. 9 Channels B : Select when using the C-MS91D Multi-Switcher and when the Multi-Switcher's "4-SEG GROUP 3" setting is set to ON.
	Initial Screen Settings Channel Designation	Select the screen to be displayed on the monitor when the power to the master Remote Controller is switched ON. Make the Remote Controller setting the same as that for the Multi-Switcher's Power ON (Camera) setting. Note: If the settings of both components are not the same, the screen set using the Remote Controller is displayed.
	Alarm Reception	There are also alarm reception settings for the Single-Channel Controller and Multi-Switcher. Be sure to set both components to the same setting. Switcher : Select to input alarms to the Multi-Switcher. Remote Controller : Select to input alarms to the Remote Controller by way of the C-AL80 Alarm Input Unit.

<Continued to next page.>

Equipment	Setting Item	Contents
C-RM500 Remote Controller	Operation Mode	Master : Select this when a single Remote Controller is used. Slave : Designate one unit as Slave when two Remote Controllers are used.
	Switcher Settings	Multi 16 : Select when connecting the C-MS161D using the dedicated remote controller lines. Multi 9A : Select when connecting the C-MS91D using the dedicated remote controller lines and when the C-MS91D's "4-Split Display Group 3" setting is set to OFF. Multi 9B : Select when connecting the C-MS91D using the dedicated remote controller lines and when the C-MS91D's "4-Split Display Group 3" setting is set to ON. Multi 16-2 : Select when connecting the C-MS161D by way of the RS-232C connector. Multi 9A-2 : Select when connecting the C-MS91D by way of the RS-232C connector and when the C-MS91D's "4-Split Display Group 3" setting is set to OFF. Multi 9B-2 : Select when connecting the C-MS91D by way of the RS-232C connector and when the C-MS91D's "4-Split Display Group 3" setting is set to ON.
	Initial Screen Settings Channel Designation	Select the screen to be displayed on the monitor when the power to the master Remote Controller is switched ON. Make the Remote Controller setting the same as that for the Multi-Switcher's Power ON (Camera) setting. Note: If the settings of both components are not the same, the screen set using the Remote Controller is displayed.
	Alarm Reception Settings	There are also alarm reception settings for the Single-Channel Controller and Multi-Switcher. Be sure to set both components to the same setting. Switcher : Select to input alarms to the Multi-Switcher. Remote Controller : Select to input alarms to the Remote Controller by way of the C-AL80 Alarm Input Unit.
C-SC100 Single-Channel Controller	Camera Number	Set the Multi-Switcher video input terminal number to which the Single-Channel Controller is connected.
	Alarm Reception Settings	There are also alarm reception settings for the Single-Channel Controller and Multi-Switcher. Be sure to set both components to the same setting. Switcher : Select to input alarms to the Multi-Switcher. Remote Controller : Select to input alarms to the Remote Controller by way of the C-AL80 Alarm Input Unit.

Note

- (1) The Multi-Switcher must also be set when using the Remote Controller. (Refer to p. 39.)
- (2) Observe the following instructions when connecting the Multi-Switcher to the C-RM500 Remote Controller:
 - When connecting the camera video output cable to the Multi-Switcher, match the Multi-Switcher's camera input terminal number to the camera's address number.
 - When wishing to control the Sensor alarm from the Multi-Switcher, set "Alarm Reception" to "Remote Unit" in the Multi-Switcher's Menu screen settings. (Refer to p. 34.)
- (3) Do not use the Multi-Switcher's Alarm input terminal. Doing otherwise could result in a Multi-Switcher malfunction.

19.3. Remote Input/Output Terminal

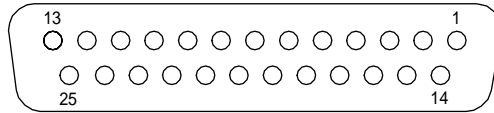

Pin No.	Pin Name	Function	Pin No.	Pin Name	Function
1	GND	GND	14	RI0	Remote input 0
2	RO0	Remote output 0	15	RI1	Remote input 1
3	RO1	Remote output 1	16	RI2	Remote input 2
4	RO2	Remote output 2	17	RI3	Remote input 3
5	RO3	Remote output 3	18	RI4	Remote input 4
6	GND	GND	19	RI5	Remote input 5
7	RO4	Remote output 4	20	-	Sequence input
8	RO5	Remote output 5	21	-	VCR selection input
9	GND	GND	22	-	Mode selection input
10	-	Sequence/VCR menu search output	23	-	Recording pattern selection input
11	-	Freeze output	24	CLK OUT	Sequence switching output
12	-	Spot selection output	25	CLK IN	Sequence switching input
13	-	Motion detection pattern selection input			

19.3.1. Remote Output Terminal

- This terminal outputs data to indicate the type of screen display shown on the monitor.
- Each remote output is an NPN open collector output, and can pass a current of up to 20 V/20 mA.
- When "0" is shown in the table at right, each output is shorted to GND. The indication "1" represents an open circuit.

Note: Do not use any other combinations than those shown in the table.

Remote I/O \ Screen Display	Pin No.	8	7	5	4	3	2
	Pin Name	RO5	RO4	RO3	RO2	RO1	RO0
Camera 1 selection output		1	-	1	1	1	1
Camera 2 selection output		1	-	1	1	1	0
Camera 3 selection output		1	-	1	1	0	1
Camera 4 selection output		1	-	1	1	0	0
Camera 5 selection output		1	-	1	0	1	1
Camera 6 selection output		1	-	1	0	1	0
Camera 7 selection output		1	-	1	0	0	1
Camera 8 selection output		1	-	1	0	0	0
Camera 9 selection output*		1	-	0	1	1	1
Camera 10 selection output*		1	-	0	1	1	0
Camera 11 selection output*		1	-	0	1	0	1
Camera 12 selection output*		1	-	0	1	0	0
Camera 13 selection output*		1	-	0	0	1	1
Camera 14 selection output*		1	-	0	0	1	0
Camera 15 selection output*		1	-	0	0	0	1
Camera 16 selection output*		1	-	0	0	0	0
Full screen selection output		1	1	-	-	-	-
Zoom selection output		1	0	-	-	-	-
4-split display 1 – 4		0	1	1	1	1	1
4-split display 5 – 8		0	1	1	1	1	0
4-split display 9 – 12		0	1	1	1	0	1
4-split display 13 – 16*		0	1	1	1	0	0
9-split display 1 – 9		0	1	1	0	1	1
9-split display 10 – 16*		0	1	1	0	1	0
10-split display 1 – 8		0	1	1	0	0	1
10-split display 9 – 16*		0	1	1	0	0	0
16-split display*		0	1	0	1	1	1

* Function only available to the C-MS161D

Pin No.	Status Output
10	Short : Sequence/VCR Menu Search mode
11	Short : Freeze mode
12	Short : Spot selection mode
24	Short/Open : Sequence switching output

19.3.2. Remote Input Terminal

- The Remote Input terminals are used to remotely control the Multi-Switcher's front panel-mounted keys by way of connected external equipment.
- The "0" in the table below indicates when an input terminal is shorted to GND.
Example. To operate the Camera 2 Selection key, simultaneously short RI0 and RI4 to GND.
- A 5V DC voltage is applied to each remote input when its circuit is opened, and a current of up to 5 mA flows when shorted. The remote input must be shorted for 100 ms or more.

Note: Do not use any other combinations than those shown in the table.

Remote I/O	Pin No.	19	18	17	16	15	14
	Pin Name	RI5	RI4	RI3	RI2	RI1	RI0
Screen Display							
Unselected		1	1	1	1	1	1
Alarm reset		1	1	1	1	1	0
Alarm hold		1	1	1	1	0	1
Spot output selection		1	1	1	1	0	0
Sequence/VCR menu search selection		1	1	1	0	1	1
Freeze-screen selection		1	1	1	0	1	0
Full-screen selection		1	1	1	0	0	1
Zoom		1	1	1	0	0	0
Shift UP		1	1	0	1	1	1
Shift DOWN		1	1	0	1	1	0
Shift RIGHT		1	1	0	1	0	1
Shift LEFT		1	1	0	1	0	0
Camera channel display		1	1	0	0	1	1
Clock display selection		1	1	0	0	1	0
Camera 1 selection		1	0	1	1	1	1
Camera 2 selection		1	0	1	1	1	0
Camera 3 selection		1	0	1	1	0	1
Camera 4 selection		1	0	1	1	0	0
Camera 5 selection		1	0	1	0	1	1
Camera 6 selection		1	0	1	0	1	0
Camera 7 selection		1	0	1	0	0	1
Camera 8 selection		1	0	1	0	0	0
Camera 9 selection		1	0	0	1	1	1
Camera 10 selection*		1	0	0	1	1	0
Camera 11 selection*		1	0	0	1	0	1
Camera 12 selection*		1	0	0	1	0	0
Camera 13 selection*		1	0	0	0	1	1
Camera 14 selection*		1	0	0	0	1	0
Camera 15 selection*		1	0	0	0	0	1
Camera 16 selection*		1	0	0	0	0	0
4-split display Group 1 selection		0	0	1	1	1	1
4-split display Group 2 selection		0	0	1	1	1	0
4-split display Group 3 selection*		0	0	1	1	0	1
4-split display Group 4 selection*		0	0	1	1	0	0
9-split display Group 1 selection		0	0	1	0	1	1
9-split display Group 2 selection*		0	0	1	0	1	0
10-split display Group 1 selection		0	0	1	0	0	1
10-split display Group 2 selection*		0	0	1	0	0	0
16-split display*		0	0	0	1	1	1

* Function only available to the C-MS161D

- In the following table, "VCR Selection (Pin No. 21)" and "Mode Selection (Pin No. 22) are only valid when [REMOTE SW OPE] is set to [REMOTE] in the Menu screen setting. (For the correct setting procedure, refer to p. 39; Front Panel Switch Operation on the Remote Control Setting screen.)

Function	Operation Selection Input	Pin No.	
Sequence Input	Sequence Input	#20	Short
VCR Selection	VCR 1 Selection	#21	Open
	VCR 2 Selection	#21	Short
Mode Selection	Camera Mode	#22	Open
	VCR Mode	#22	Short
Recording Pattern Selection	Recording Pattern 1 Selection	#23	Open
	Recording Pattern 2 Selection	#23	Short
Sequence Switching Input	Sequence Switching Input	#25	Short/open
Motion Detection Pattern Selection	Motion Detection Pattern 1 Selection	#13	Open
	Motion Detection Pattern 2 Selection	#13	Short

19.3.3. Recording Pattern Selection Input Terminal (Remote I/O Terminal Pin #23)

For more information on this function, refer to p. 77; Recording Pattern Function.

- The Recording Pattern Selection input terminal is used to allow connected external equipment to switch recording patterns. When using this terminal, set "REC PTN OPE" to "REMOTE" in the Menu screen setting. (For the correct setting procedure, refer to p. 39; Remote Control Settings.)
- Recording is made in "Recording Pattern 1" when this terminal is opened from GND, and in "Recording Pattern 2" when shorted to GND.
- A 5V DC voltage is applied to this terminal when its circuit is open, and a current of up to 5 mA flows through it when shorted. This terminal must be shorted for 100 ms or more.

19.3.4. Motion Detection Pattern Selection Input Terminal (Remote I/O Terminal Pin #13)

For more information on this function, refer to p. 76; Motion Detection Pattern Function.

- The Motion Detection Pattern Selection input terminal is used to allow connected external equipment to switch recording patterns. When using this terminal, set "MOTION PTN OPE" to "REMOTE" in the Menu screen setting. (For the correct setting procedure, refer to p. 39; Remote Control Settings.)
- Recording is made in "Motion Detection Pattern 1" when this terminal is opened from GND, and in "Motion Detection Pattern 2" when shorted to GND.
- A 5V DC voltage is applied to this terminal when its circuit is open, and a current of up to 5 mA flows when shorted. This terminal must be shorted for 100 ms or more.

19.3.5. Sequence Switching I/O Terminal (Remote I/O Terminal Pins #24 and 25)

- Sequential displays are normally switched by the time interval preprogrammed into the Multi-Switcher. The Sequence Switching I/O terminal is used in systems having two or more Multi-Switchers in order to synchronize the switching timing of each Multi-Switcher. (Refer to p. 78.)
- Connect the Sequence Switching output terminal of the master Multi-Switcher, for which the dwell time is determined, to the Sequence Switching input of the slave Multi-Switcher.
- Set "Sequence Switching Interval" for the Master unit in the Menu screen setting, and set the interval for the Slave unit to "00." (For the correct setting procedure, refer to p. 35.)
- A 5V DC voltage is applied to this terminal when its circuit is open, and a current of up to 5 mA flows when shorted. This terminal must be shorted for 100 ms or more.
- The Sequence Switching output terminal is an NPN open collector output, and can pass a current of up to 20 V/20 mA.

20. MOTION DETECTION

20.1. About the Motion Detection Function

The Multi-Switcher features built-in Motion Detection circuitry that detects movement in the camera scene by the change in brightness. The number of recorded frames for the detected camera can be set to increase when such changes are detected or the connected VCR can be switched to alarm recording mode while providing a warning by displaying alarm information on the monitor and sounding a buzzer. It is also possible to sound an external buzzer by way of the Alarm output terminal. In addition, only the camera image in which movement was detected can be recorded to save such recording media as VCR tape.

Note

- The Motion Detection function cannot be effectively used for the following camera images owing to increased possibility of detection errors occurring. Disable the Motion Detection function or set the area setting for such sections to OFF.

(1) Snow, sea waves and trees swaying by wind.

(2) Images in which brightness changes due to lightning or sudden change in weather.

(3) Images in which fluorescent lamps or monitors produce flickering.

- The Motion Detection function cannot be used when the camera itself moves, such as Combination cameras or cameras installed on a pan/tilt head.
- The Motion Detection function requires approx. 15 seconds to commence operation after the power is switched ON.

20.2. Basic Motion Detection Operations

20.2.1. Detection Function and Setting/Operation

[Detection Frames]

The entire screen is divided into 16 horizontal x 12 vertical frames (192 frames in all), with changes in each frame being detected.

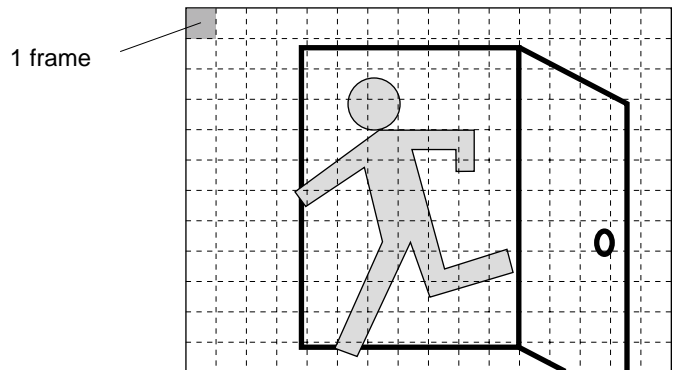

[Detection Areas]

By restricting the area to be detected, unwanted malfunctions can be reduced. Divide the entire screen into 4 horizontal x 4 vertical areas, and set the areas for which the change of image movement is detected to ON, and the area that requires no detection to OFF.

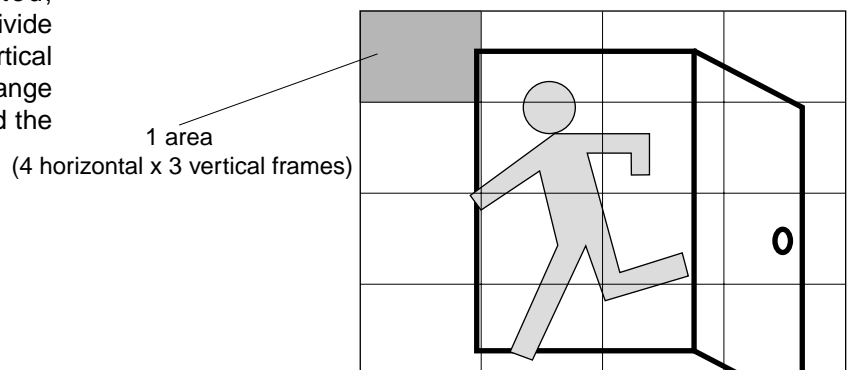

[Detection Size]

With the size of a subject to be detected set by horizontal and vertical frames in 1 frame units, the Motion Detection function only operates when all frames within the set size change.

(Example) Detection size: 2 horizontal x 5 vertical frames
A person is detected, but a cat is not.

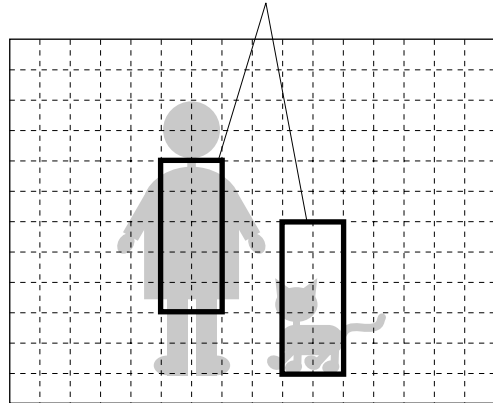

[Detection Sensitivity]

Movement in the scene is detected by the change of brightness, and its sensitivity can be set in 5 levels (1 – 5). Sensitivity goes up as the number increases.

[Detection Standby Time]

In some cases, when the brightness of a subject suddenly changes because the light has been turned on or off or the weather has suddenly changed, a "movement" change is detected, triggering the detection function. Such misoperations can be reduced by setting the detection standby time.

The Multi-Switcher monitors each camera's data and compares it with the reference data (the same camera's previous data), and detects a change if the brightness differs.

Setting the detection standby time to OFF causes the Motion Detection to be triggered as soon as a change in brightness is detected. However, when set to "0.5S" (0.5 seconds), "1S" (1 second), "2S" (2 seconds), "3S" (3 seconds) or "5S" (5 seconds), even if the Multi-Switcher detects a change, it checks to see if there is a change after the preset standby time elapses, and only permits the Motion Detection to be triggered when the change is detected again.

When the detection standby time is set, the function operates as follows:

[In the case of a light turning on]

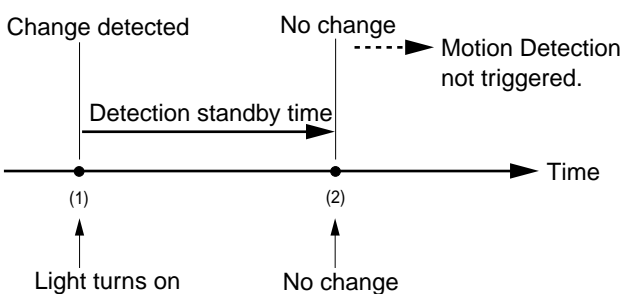

[In the case of a person entering the scene and moving]

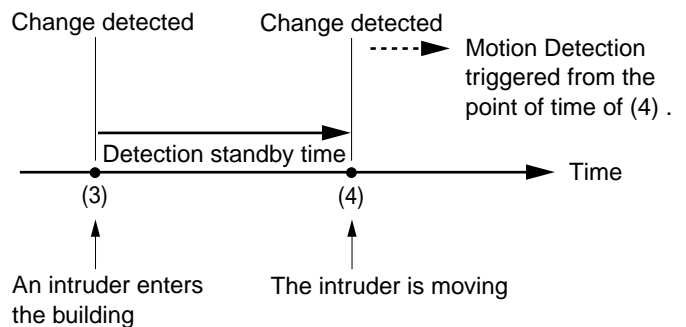

Note: The Multi-Switcher may detect changes in brightness caused by the enabling of the camera high-sensitivity function or AGC function as motion. In such cases, set the detection standby time to compensate for the time length of the change.

Also, take care that when the brightness level greatly changes, if the camera uses a DC (auto-iris) lens, the lens iris action takes time, causing a brightness change to be interpreted as motion, even if the detection standby time is set.

[Detection Output]

Delivers an output from the rear panel-mounted Alarm Input terminal (#18) during the motion detection interval +5 seconds. (Refer to p. 66; Alarm Input/Output Terminal.)

20.2.2. Switcher Operation in Response to Motion Detection

After a movement in the camera scene is detected, the Multi-Switcher operates as follows, depending on the menu screen setting:

(1) When the Motion Detection function is set to ON...

Increases the number of recording frames used by the VCR or other recording device connected to the detected camera. (Motion Detection operation.)

"Detect motion" operation continues until the Motion Detection interval + 5 seconds elapses.

[Operation interval]

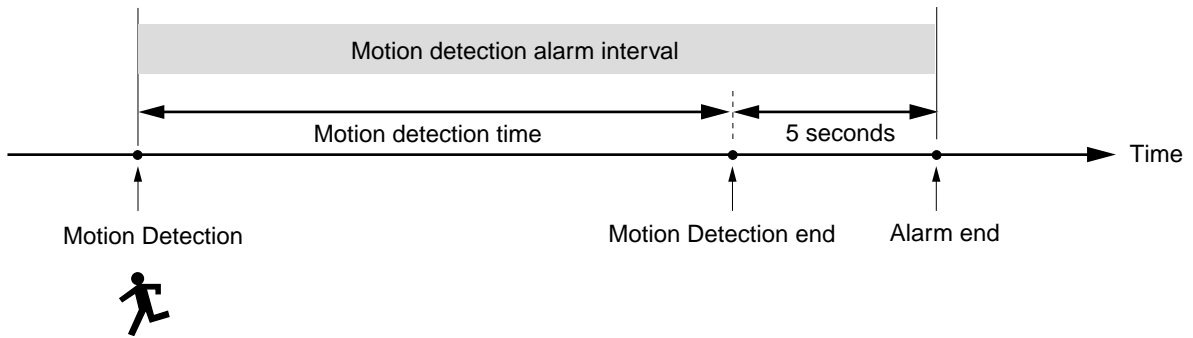

[Frame recording example]

Shown below is an example of frame recording when 8 cameras are connected:

- Normal operation

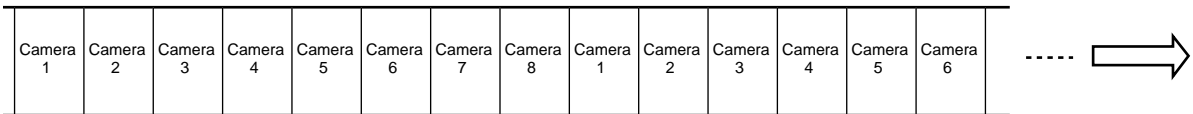

- When movement change is detected for Camera 3...

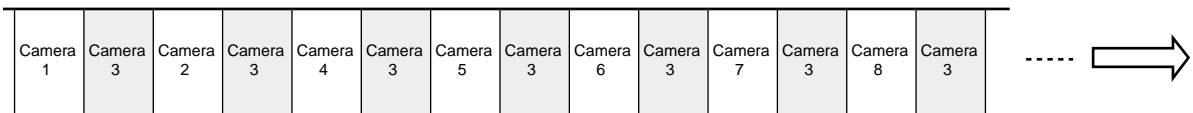

- When movement change is detected for Cameras 3, 5 and 7...

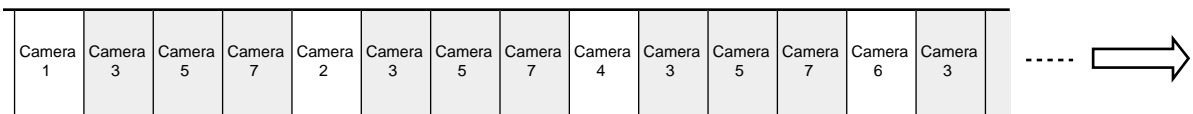

(2) When the Motion Detection function is set to "Alarm (OR)" or "Alarm (AND)"

the detection of movement change is handled as an alarm.

If set for "Alarm (OR)," alarm operation is started (regardless of Sensor alarm activation) when a movement change is detected.

If set for "Alarm (AND)," alarm operation is only started when the movement is detected and at the same time, Sensor alarm is also activated. (For more information, refer to p. 62; Motion Detection Alarm.)

20.3. Motion Detection Pattern Function

- Two separate Motion Detection patterns can be set: "Motion Detection Pattern 1" and "Motion Detection Pattern 2." Use these patterns when different cameras need to be recorded during daytime/nighttime or workday/holiday schedules.
- Motion detection patterns can be set on the menu screen or in "Motion Detection Pattern selection input terminal" or "RS-232C connector". For details, refer to the following:

[About the terminal]

p. 68; Motion Detection Pattern selection input terminal

[About the setting method]

- Selection of Motion Detection Pattern 1 or 2. (Refer to p. 36; Motion Detection Pattern Selection of the Option 1 Settings screen.)
- Changing the Motion Detection Pattern (Internal/Remote/RS232C). (Refer to p. 39; Motion Detection Pattern Operation of the Remote Settings screen.)
- Motion Detection Pattern Settings. (Refer to p. 42; Motion Detection Pattern Settings.)

21. OTHER FUNCTIONS

21.1. When Using 2 VCRs (Continuous Recording Function)

Continuous recording can be made by alternately using two VCRs.

When either VCR records to its tape end and stops recording, the other VCR automatically begins to record. (Refer to p. 84; Connection Examples: Connections When Using Two VCRs.)

Note

If using TOA's C-VT242 or C-VT962 Time-Lapse VCR, when the tape of the first VCR has recorded to its end, eject the tape once and replace. If not ejected, the first VCR does not begin to record when the second VCR has recorded to its tape end and stopped recording.

When performing Alarm recording using the Sensor alarm function, set so that alarm recording does not activate the VCR in pause mode. Set the VCR setting items ALARM READY or EMERGENCY RECORDING to OFF for both VCRs.

21.2. Recording Pattern Function

- Two separate Recording patterns can be set: "Recording Pattern 1" and "Recording Pattern 2." Use these patterns when different cameras need to be recorded during daytime/nighttime or workday/holiday schedules.
- Recording patterns can be set on the menu screen or in "Recording Pattern selection input terminal" or "RS-232C connector". For details, refer to the following:

[About the terminal]

p. 72; Recording Pattern selection input terminal]

[About the setting method]

- Selection of Recording Pattern 1 or 2. (Refer to p. 36; Recording Pattern Selection of the Option 1 Settings screen.)
- Changing the Recording Pattern (Internal/Remote/RS232C). (Refer to p. 39; Recording Pattern Operation of the Remote Settings screen.)
- Recording Pattern Settings. (Refer to p. 41; Recording Pattern Settings.)

21.3. Auto-Recognition During Time-Lapse Recording

The switcher control input is connected when a time-lapse VCR or digital recorder is used to make time-lapse recordings. The "Auto-Recognition" function automatically maintains the switcher control signal, even if this signal is cut due to such accidents as cable disconnection or faulty contact, allowing the time-lapse VCR to continue recording. This ensures no important recordings are missed, because recording is not interrupted by such accidents as cable disconnection.

- The Multi-Switcher continues operation by automatically recognizing the recording interval (recording mode) that was last used before the switcher control signal was cut.
- When connection is restored from Auto-Recognition mode after the switcher control signal was cut, the time-lapse VCR follows the automatically restored switcher control signal to continue recordings.

Note: When using a recording interval of longer than 60 seconds, set "Auto-Recognition" to OFF in the menu screen setting. (Refer to p. 32.)

- The [*] indication is displayed on video images during Auto-Recognition operation. (Refer to p. 15.)
- The Auto-Recognition function can be individually set to ON or OFF for normal recording (other than Alarm recording) and Alarm recording when making time-lapse recordings. (Refer to p. 32 and p. 33; Auto-Recognition and Alarm Auto-Recognition of the Recording Settings screen.)

21.4. Sequential Switching Timing Adjustment

- When using two or more Multi-Switchers, the dwell time (switching interval) of the master Multi-Switcher can be matched to that of the slave Multi-Switcher.
- Making connections between the master and slave units as shown in the figure permits the slave unit's Monitor Outputs 1 and 2 to be sequentially switched at the same dwell time (2 seconds in the following example) as set for the master unit's Monitor Output 1.

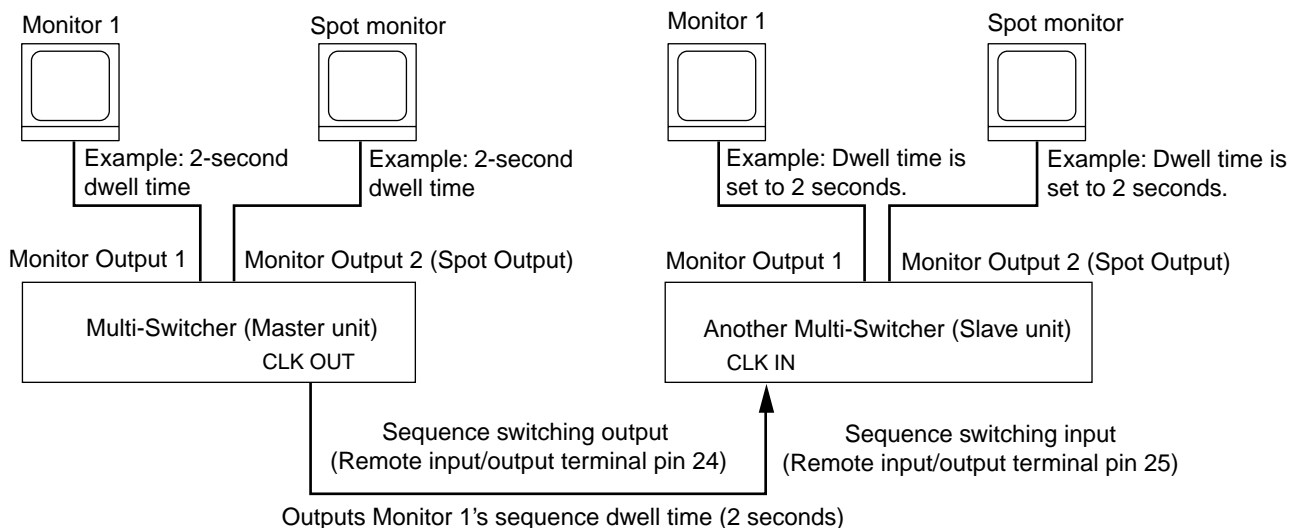

- The following table shows the settings of the master and slave units in the above example. (Refer to p. 35; Option 1 Settings.)

Setting Item	Master Unit	Slave Unit
SEQUENCE DWELL TIME (MONITOR OUT)	Set interval (01 – 99 seconds). Above example: Set to 2 seconds.	Set to "00"
SEQUENCE DWELL TIME (SPOT OUT)	Set interval (01 – 99 seconds). Above example: Set to 2 seconds.	Set to "00"

21.5. Monitor Indication Adjustment

The following monitor items can be set or adjusted. (Refer to p. 38; Other Settings Screen.)

Setting Item	Value	Contents
BACKGROUND COLOR	BLACK / BLUE	Screen background color displayed when an unconnected camera or unrecorded VCR playback is selected can be selected.
BORDER LINE	ON/ OFF	Whether or not to use the border lines in multi-screen display can be set.
H. POSITION	-7 to +7 (0)	Horizontal position in multi-screen display can be adjusted.
V. POSITION	-7 to +7 (0)	Vertical position in multi-screen display can be adjusted.

Note: Underlined settings represent factory-preset settings.

21.6. Key Locking

The front panel operation keys can be locked to prevent accidental changes of key settings. Note, however, that remote operation can still be performed even while the keys are locked.

Locking the Keys

Press the Alarm Hold key while holding down the Spot Selector key. The light of the Spot Selector key lights, indicating that the front panel operation keys have been locked. If a key is operated, the warning indication "ALL KEYS LOCKED" is displayed for 2 seconds.

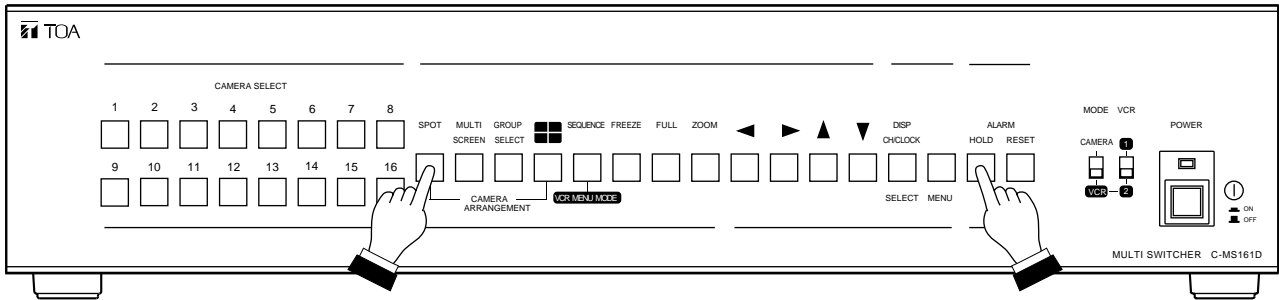

Releasing Key Locking

Under the key locking condition, press the Alarm Hold key while holding down the Spot Selector key. The light of the Spot Selector key extinguishes and front panel key locking is released.

21.7. Screen Display When Power Is Switched On

The monitor output screens to be displayed when the power is switched on are as shown in the following table. Screen displays that appear immediately after the power is switched on can be changed in Option 1 Settings (p. 31).

		Camera/VCR Mode Selector Switch Settings	
		"Camera" position	"VCR" position
Factory Settings		4-segment split sequence	4-segment split display (Cameras 1 – 4)
Screen displays that can be set in Option 1 Settings	C-MS161D	Full screen 1 – 16 Sequence 4-segment split display (Group 1) 4-segment split display (Group 2) 4-segment split display (Group 3) 4-segment split display (Group 4) 4-segment split sequence 9-segment split display (Group 1) 9-segment split display (Group 2) 10-segment split display (Group 1) 10-segment split display (Group 2) 16-segment split display	Full screen 1 – 16 4-segment split display (Group 1) 4-segment split display (Group 2) 4-segment split display (Group 3) 4-segment split display (Group 4) 9-segment split display (Group 1) 9-segment split display (Group 2) 16-segment split display
	C-MS91D	Full screen 1 – 9 Sequence 4-segment split display (Group 1) 4-segment split display (Group 2) 4-segment split sequence 9-split display 9-segment split display 10-segment split display	Full screen 1 – 9 4-segment split display (Group 1) 4-segment split display (Group 2)

Note: The Spot Output provides a sequential display when the power is switched on.

22. CONNECTIONS

22.1. Preparation Before Making Connections

Switch off the power to the Multi-Switcher and all equipment connected to the Multi-Switcher.

22.2. Camera Connections

Up to 16 cameras can be connected to the C-MS161D, and up to 9 cameras to the C-MS91D.

22.2.1. When using Single-cable cameras (Refer to p. 82.)

Connect the Multi-Switcher's Video Input terminal to the Camera Drive Unit's Camera Output terminal.

22.2.2. When using 24V AC or AC mains cameras (Refer to p. 86.)

Connect the Multi-Switcher's Video Input terminal to the camera's Video Output terminal.

Note: The Multi-Switcher's Video Input terminal is automatically terminated at 75Ω. When bridging the camera's video signal using the Multi-Switcher's Video Output terminal, the terminating resistance is automatically disabled, making the input impedance high.

22.3. Monitor TV Connections (Refer to p. 82.)

- Connect the Multi-Switcher's Monitor Output terminal to the monitor's Video Input terminal.
- When 2 VCRs are used to record images and voice, connect the Multi-Switcher's Audio Output terminal to the monitor's Audio Input terminal.
- The Multi-Switcher has 2 monitor output terminals. Monitor Output 2 is preset as Spot Output by the factory and can only be used for full screen and sequential displays. (Refer to p. 38; Monitor Output 2 of the Other Settings screen.)

22.4. VCR Connections (Refer to p. 82.)

- Connect the Multi-Switcher's VCR Output terminal to the VCR's Video Input terminal, and the Multi-Switcher's VCR Input terminal to the VCR's Video Output terminal.
- When 2 VCRs are used to record images and voice, connect the Multi-Switcher's Audio Input Terminal 1 to VCR 1's Audio Output terminal and the Multi-Switcher's Audio Input Terminal 2 to VCR 2's Audio Output terminal.
- When a time-lapse VCR is used, connect the Multi-Switcher's Control Input terminal to the time-lapse VCR's SW CONTROL OUT terminal or CLOCK OUT terminal.
- When making Alarm recordings, connect the Multi-Switcher's Alarm Output terminal to the time-lapse VCR's Alarm Input terminal. When using a time-lapse VCR that requires an alarm reset signal, connect the Multi-Switcher's Alarm Reset Output terminal to the time-lapse VCR's Alarm Reset (RST) input.

22.5. Dedicated Remote Controller Terminal Connections

The Dedicated Remote Controller terminal permits connection of either the C-RM100 Dedicated Remote Controller or the C-SC100 Single-Channel Controller. (Refer to p. 67; Remote Controller Usage.)

22.5.1. Connection Cables

Use CPEV-S cables with a diameter larger than 0.65mm. The maximum distance that can be connected by way of the dedicated remote controller cable is 1.2km, including the distances between connected equipment.

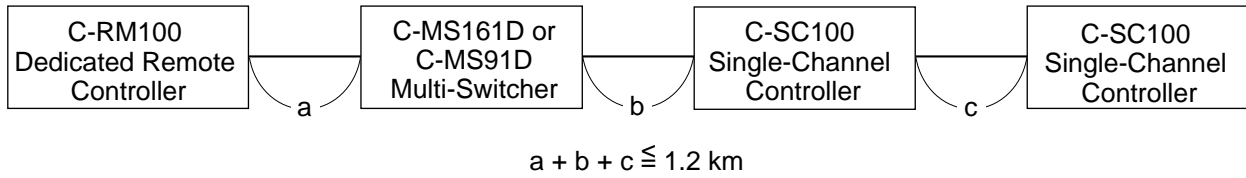

22.5.2. Connected Equipment Termination Switch Settings

Equipment connected to a midpoint in the dedicated remote controller cable:
Set the termination switch to OFF.

Equipment connected to both ends of the dedicated remote controller cable:
Set the termination switch to ON.

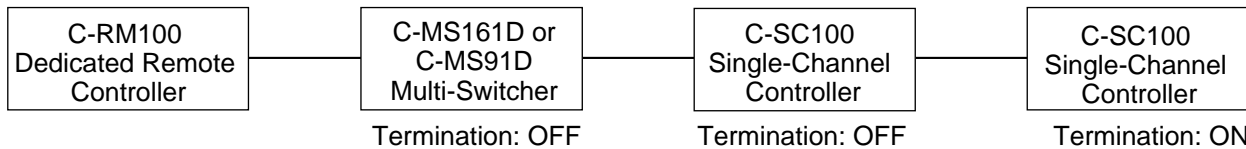

Note: The dedicated remote controller's termination is always set to ON. Be sure to connect the dedicated remote controller to the end of the dedicated remote controller line.

22.6. RS-232C Terminal Connections

The Multi-Switcher can be remotely controlled by a PC or other external equipment by way of its RS-232C port.

Note

- (1) The control software program is not available from TOA.
- (2) Please ask your TOA dealer regarding the details of the method of control.

- RS-232C connector pin arrangement

The signal name of each pin of the RS-232C connector (D-sub 9 pins) is as shown below.

Pin No.	Signal Name
1	Not connected
2	RXD (Receiving data)
3	TXD (Transmitting data)
4	Not connected
5	GND
6	Not connected
7	RTS (Request to send)
8	CTS (Clear to send)
9	Not connected

Note: The plug for the RS-232C connector is not supplied with the Multi-Switcher.

23. CONNECTION EXAMPLES

23.1. Basic Connections

23.1.1. C-MS161D Multi-Switcher

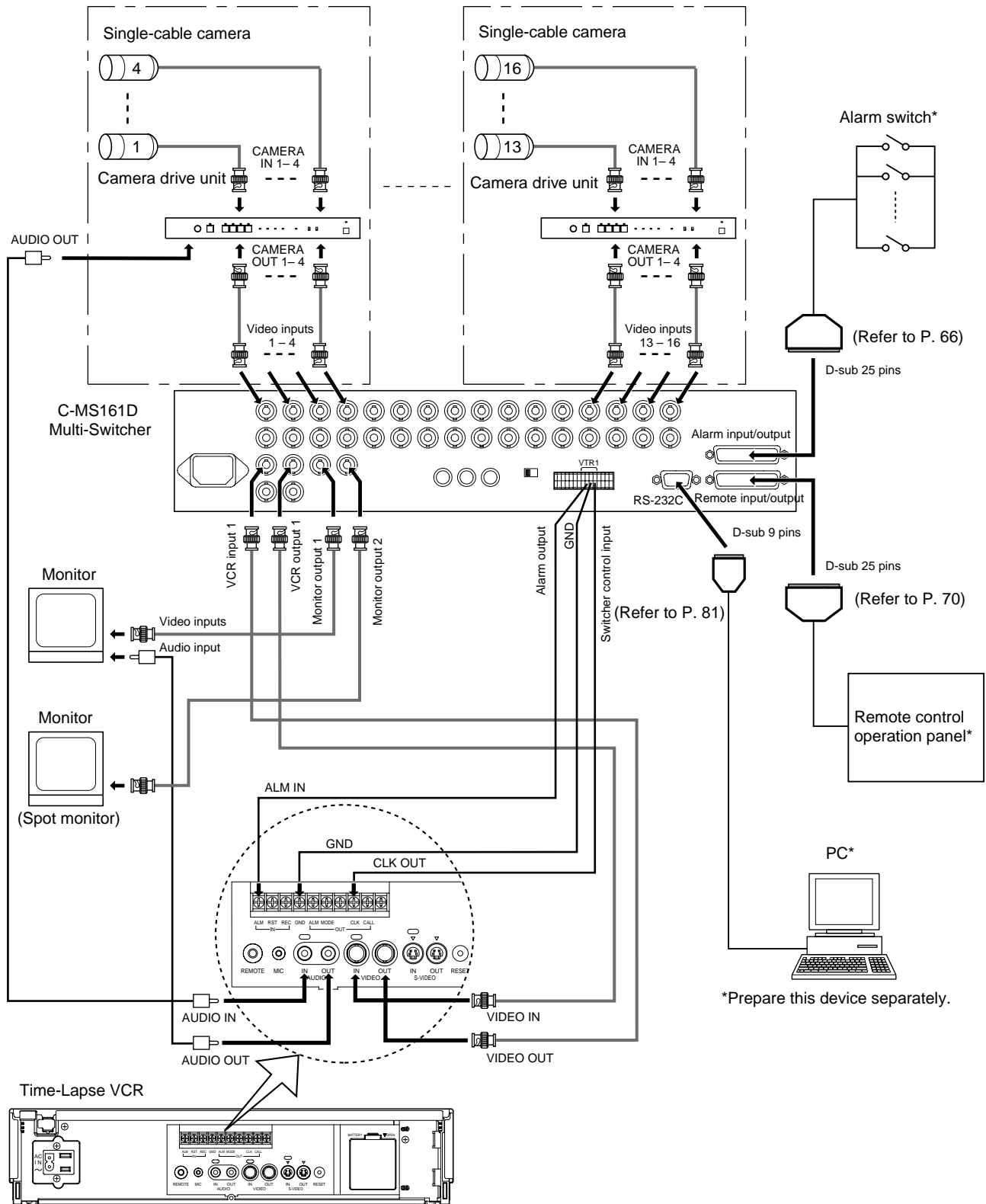

23.2.2. C-MS91D Multi-Switcher

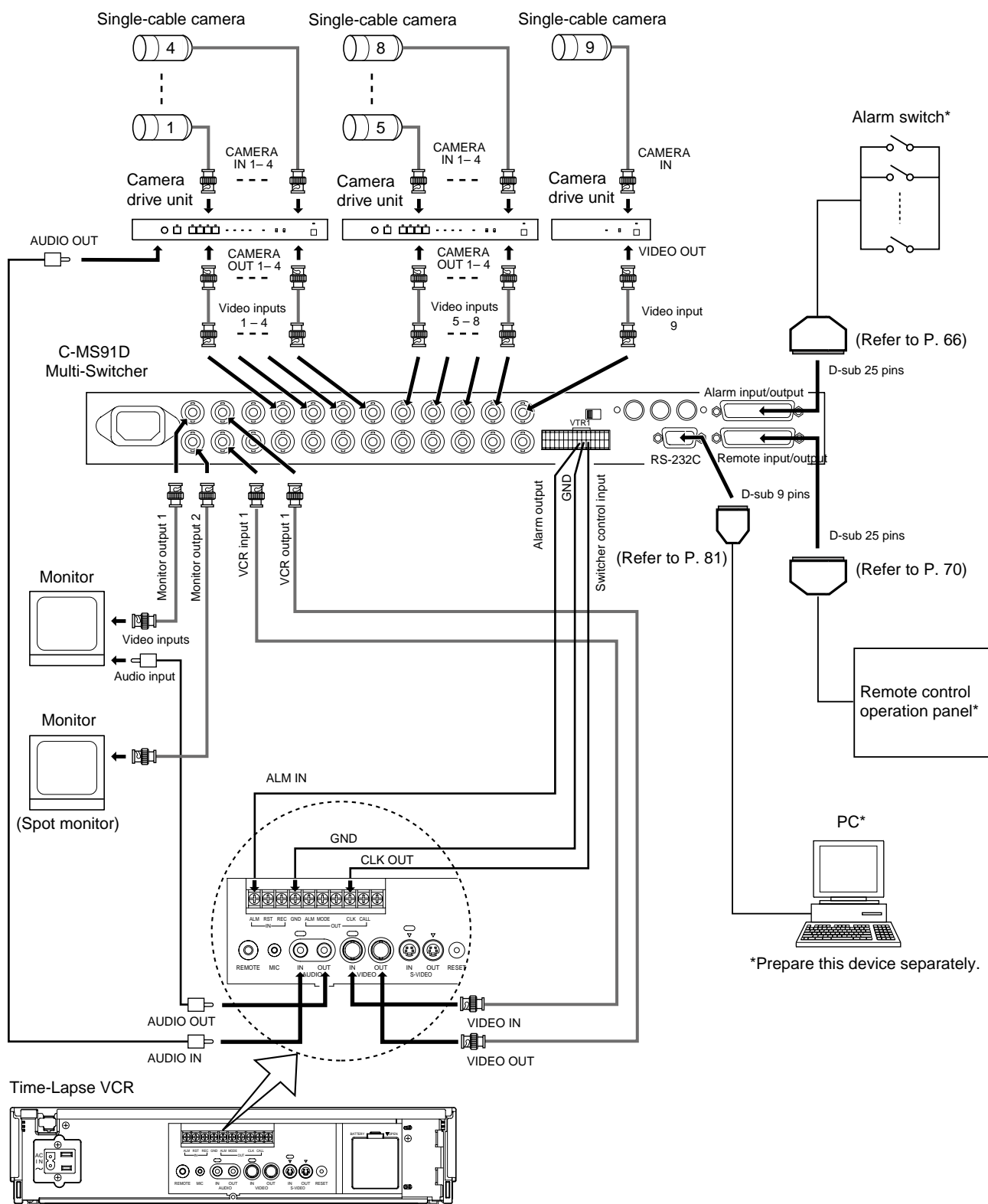

*Prepare this device separately.

23.2. Connections in Systems Using Two VCRs

23.2.1. C-MS161D Multi-Switcher

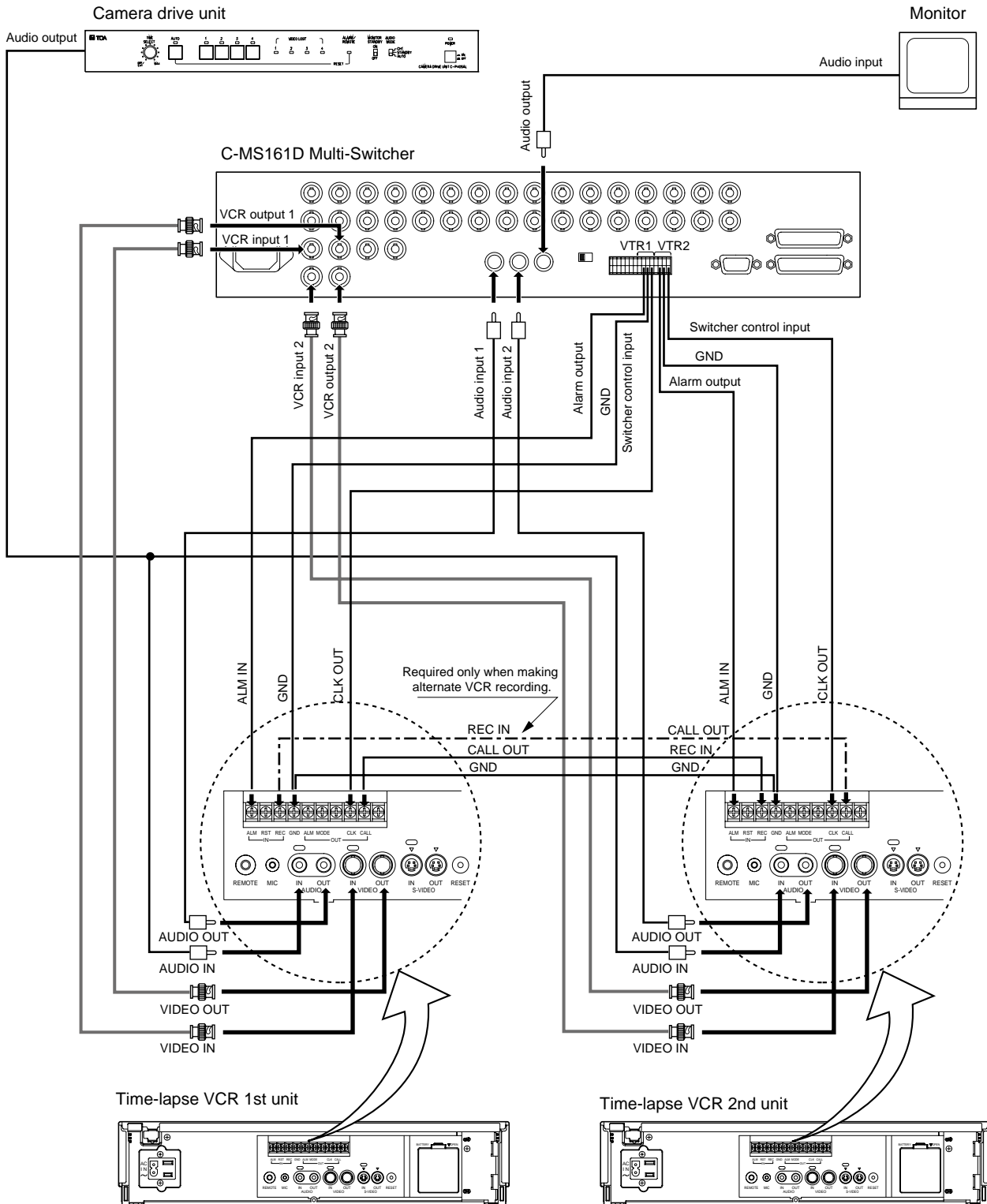

23.2.2. C-MS91D Multi-Switcher

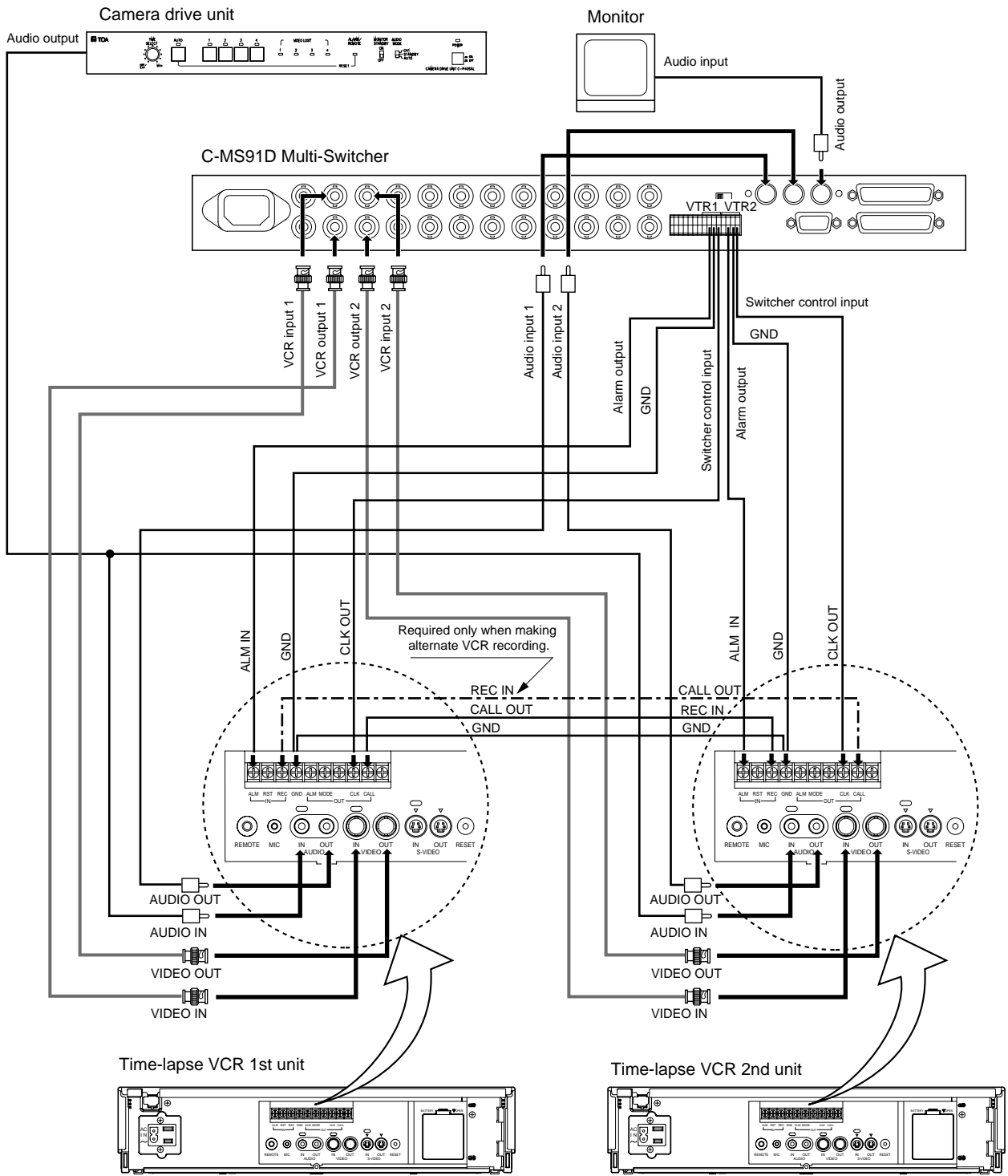

23.3. Connections Using the Dedicated Remote Controller Line

23.3.1. Connection to the C-RM100 Remote Controller

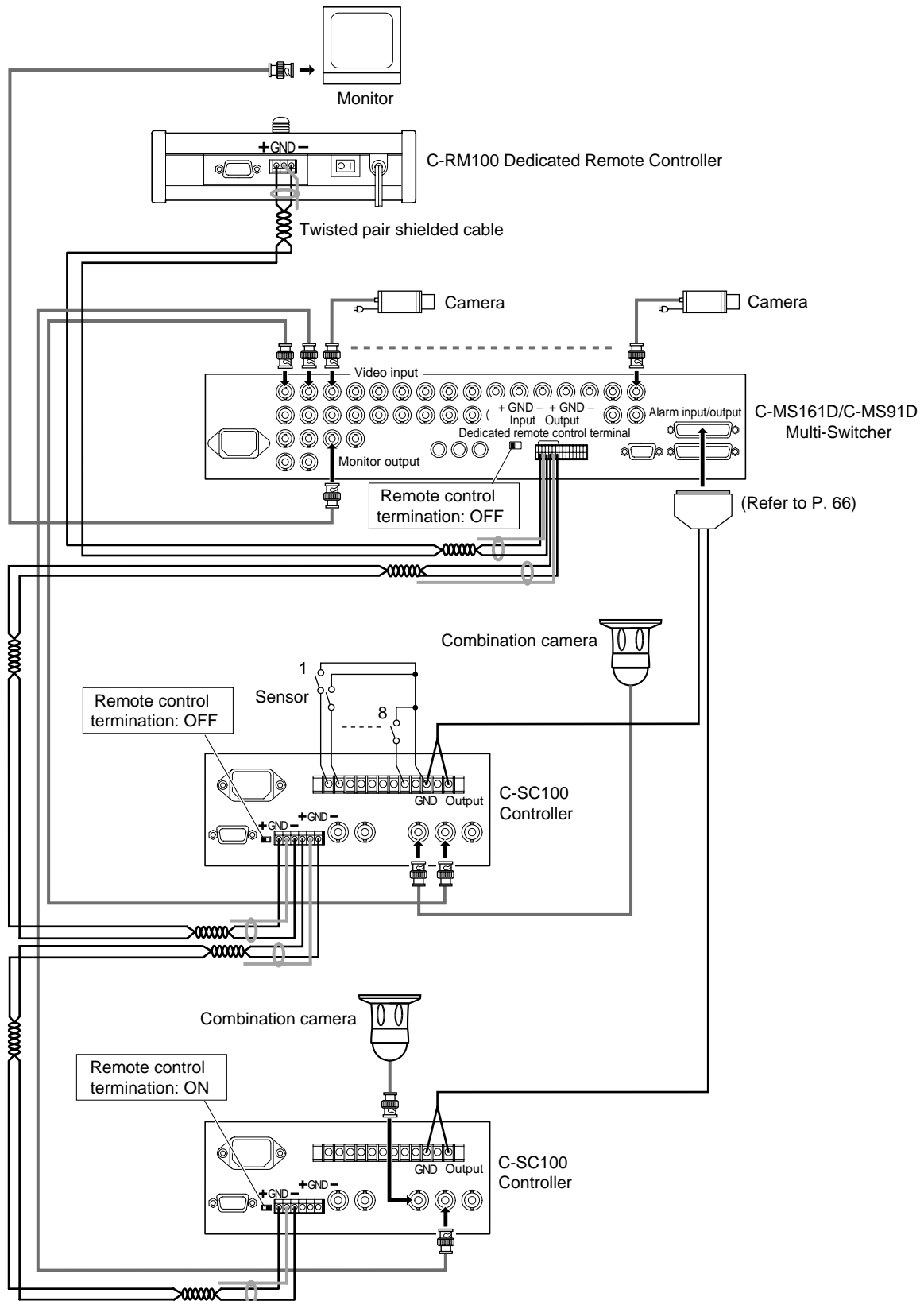

Note: For details regarding functions and operation, refer to p. 67; Remote Controller Usage.

23.3.2. Connection to the C-RM500 Remote Controller

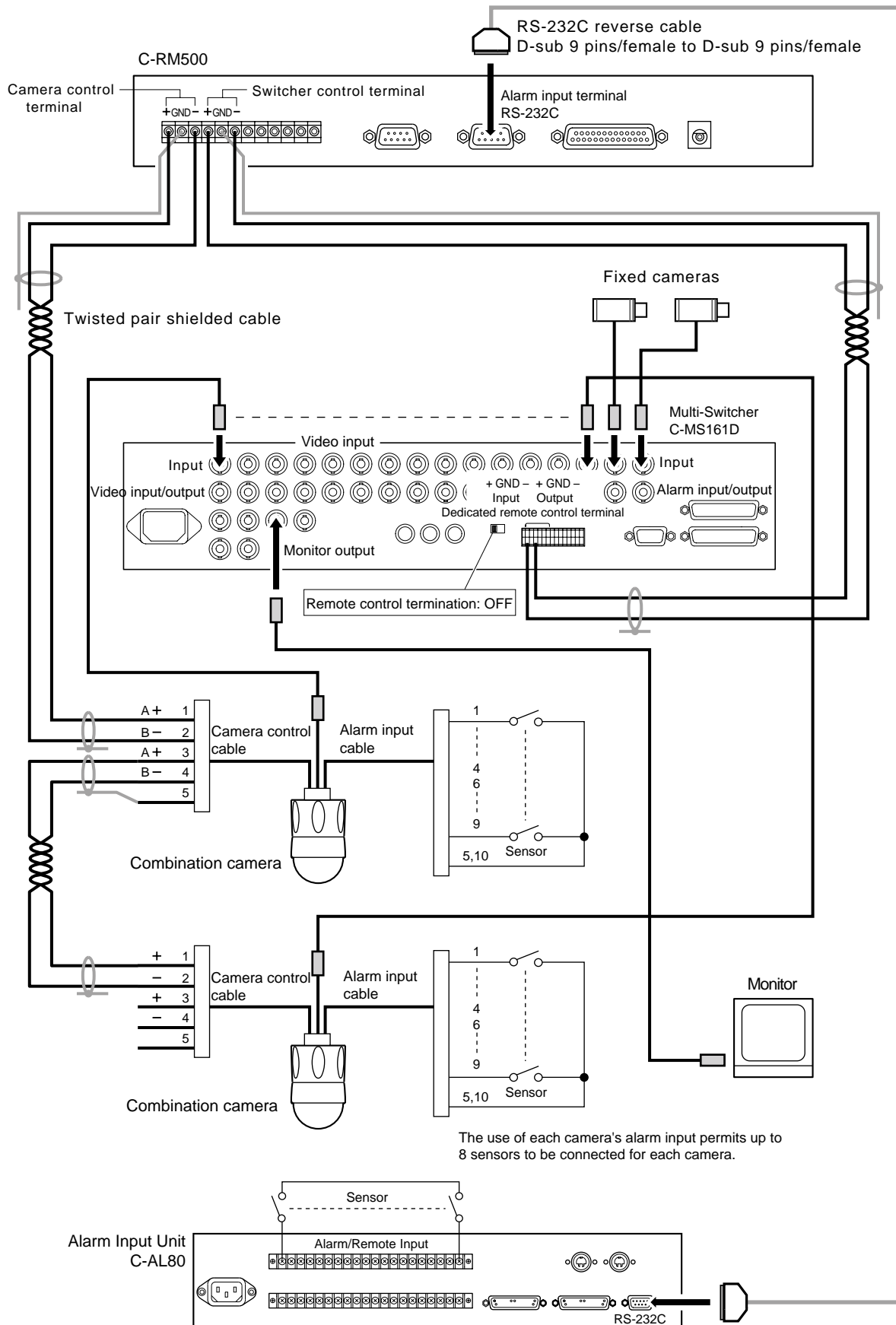

24. RACK MOUNTING

[C-MS161D Multi-Switcher]

Use the optional MB-23B Rack Mounting Bracket when mounting the Multi-Switcher in an equipment rack. Remove the 4 plastic feet attached to the bottom panel.

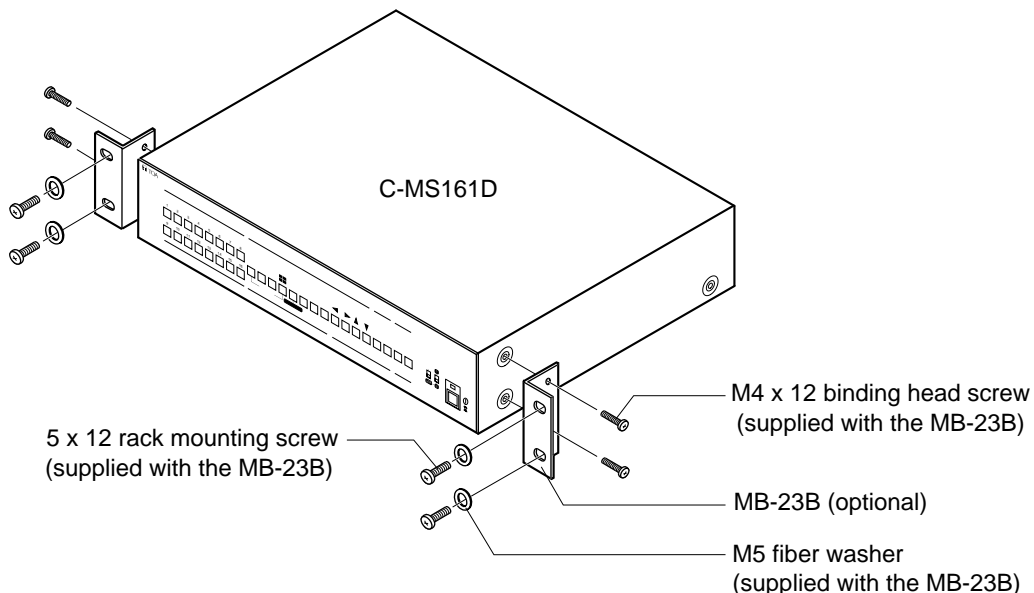

[C-MS91D Multi-Switcher]

Use the optional MB-15B Rack Mounting Bracket when mounting the Multi-Switcher in an equipment rack. Remove the 4 plastic feet attached to the bottom panel.

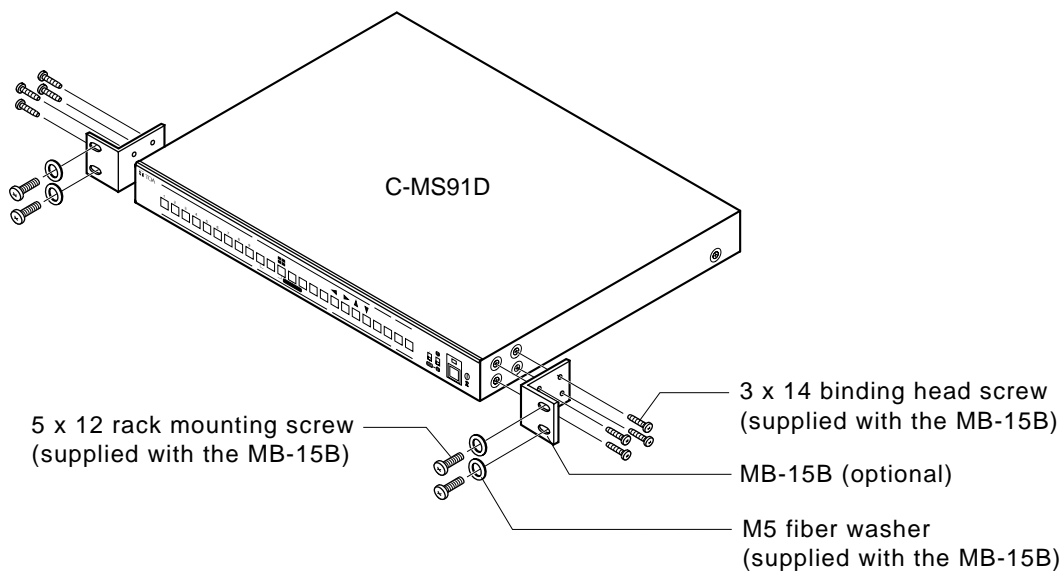

Note

- Use the Multi-Switcher in locations with ambient temperature of between +0°C and +40°C.
- Be sure to mount the Multi-Switcher below the heat generating components, and mount the perforated panel between the Multi-Switcher and such a heat generating component as required.
- Avoid installing the Multi-Switcher in locations exposed to vibration.

25. TROUBLESHOOTING

Symptom	Cause
<ul style="list-style-type: none"> • Cannot switch power ON. 	<ul style="list-style-type: none"> • Supplied power cord is not connected to the Multi-Switcher's inlet and AC power outlet.
<ul style="list-style-type: none"> • Monitor screen does not change even if the front panel operation keys are pressed. 	<ul style="list-style-type: none"> • Key Lock function enabled.
<ul style="list-style-type: none"> • Camera images not displayed on the screen. 	<ul style="list-style-type: none"> • Power is not supplied to the camera or monitor. • The Camera/VCR Mode Selector switch is set to the VCR position. • Camera's lens cap is not removed. • Cables are not correctly connected. • BNC plug is not correctly soldered. • Monitor image and black level are not correctly adjusted.
<ul style="list-style-type: none"> • Cannot play back recorded tapes. • Recorded images are not displayed. 	<ul style="list-style-type: none"> • The Multi-Switcher is not correctly connected to the VCR. • Playback attempted with the Camera/VCR Mode Selector switch set to CAMERA position.
<ul style="list-style-type: none"> • Cannot play back tapes recorded in long hour mode (L12 or greater). • Some camera images are not played back. 	<ul style="list-style-type: none"> • Recording Mode is not set to "T.L." (Time-Lapse) in the menu screen settings. • Cables between the Multi-Switcher's Switcher Control terminal and the VCR are not correctly connected.
<ul style="list-style-type: none"> • Recorded camera images other than those selected are displayed when played back. • Images are displayed for an unrecorded camera. • Noise bars appear. • Strange colors overlap with each other. 	<ul style="list-style-type: none"> • VCR's playback mode is set to mode L12, L18, L24 or L30. Use other modes because some VCRs cannot correctly play back in mode L12, L18, L24 or L30. • VCR's tracking is not correctly adjusted. • Tape plays back in reverse. (Reverse playback may cause unselected cameras to be displayed.) • Tape segment between recorded scenes or tape leader is played back. (In such playback, unselected cameras may be displayed.) • VCR playback mode was changed or the VCR paused during playback. (Unselected cameras may be displayed if the VCR mode is changed or the VCR paused during playback.) • Tape is fast-forwarded or rewind. • VCR was paused after fast-forward or rewind playback.
<ul style="list-style-type: none"> • If the recorded tape is played back on the multi-screen, images are not updated in recorded camera order. 	<ul style="list-style-type: none"> • Motion Detection function is enabled. (If "MOTION DETECTION" is set to ON in the menu screen settings, the recording order will change.)
<ul style="list-style-type: none"> • When in VCR mode, green or pink noise appears on the screen of unrecorded cameras. • When in VCR mode, green noise appears on the whole screen. 	<ul style="list-style-type: none"> • Not a failure. This symptom may occur when the unrecorded tape sections are played back or the tape is stopped.
<ul style="list-style-type: none"> • Playback of the recorded tape provides freeze-frame displays. 	<ul style="list-style-type: none"> • VCR was paused during playback. • Unrecorded tape section played back beyond the recorded section. • The Freeze key is pressed. (Pressing the Freeze key displays the flashing "Freeze" indication on the screen.)

Symptom	Cause
<ul style="list-style-type: none"> • During playback of the recorded tape, a buzzer sounds at tape sections not recorded. 	<ul style="list-style-type: none"> • Unrecorded tape section played back beyond the recorded section. (Buzzer may sound when unrecorded tape sections are played back.) • Tape segment between scenes is played back. (Buzzer may sound when such tape segments are played back.)
<ul style="list-style-type: none"> • Sensor Alarm does not operate. 	<ul style="list-style-type: none"> • "SENSOR ALARM" is not set to ON in the menu screen settings. • Sensor Input terminal is not correctly wired. • Approximately 15 seconds have not yet elapsed since the power was turned on. The Sensor alarm function does not operate for 15 seconds after the power is turned on.
<ul style="list-style-type: none"> • Video Loss alarm does not operate. 	<ul style="list-style-type: none"> • "VIDEO LOSS ALARM" is not set to ON in the menu screen settings.
<ul style="list-style-type: none"> • Buzzer does not sound when Sensor alarm or VCR playback alarm is triggered. 	<ul style="list-style-type: none"> • "BUZZER" is not set to ON in the menu screen settings.
<ul style="list-style-type: none"> • Camera titles are not displayed. 	<ul style="list-style-type: none"> • "TITLE (MONITOR)" is set to OFF in the menu screen settings.
<ul style="list-style-type: none"> • Title, date and time are not displayed on the VCR playback screen. 	<ul style="list-style-type: none"> • "TITLE (VCR)" and "DATE/TIME (VCR)" are set to OFF in the menu screen settings.
<ul style="list-style-type: none"> • Date and time indications are displayed overlapped on the VCR playback screen. • Two date and time indications are displayed. 	<ul style="list-style-type: none"> • VCR date and time indications are set to ON. Refer to the VCR settings.
<ul style="list-style-type: none"> • Clock goes too fast or too slow while the Multi-Switcher's power is turned off. 	<ul style="list-style-type: none"> • Built-in lithium battery may be approaching the end of its life. Contact your TOA dealer.
<ul style="list-style-type: none"> • Camera images are displayed although the Multi-Switcher is in VCR mode and the VCR is not being played back. 	<ul style="list-style-type: none"> • VCR is paused. While the VCR is in pause or recording mode, the image to be recorded on the VCR is output from the VCR and displayed. (Other camera images may also be momentarily mixed and displayed.)
<ul style="list-style-type: none"> • Camera image movements are very jerky. (Intervals between intermittent motions take 1 second or more.) 	<ul style="list-style-type: none"> • Set to VCR mode. This is the same symptom as above, and camera images are displayed even in VCR mode.
<ul style="list-style-type: none"> • Motion Detection function is triggered although no one enters the scene or no change in movement is detected. 	<ul style="list-style-type: none"> • Objects are moving in the background, such as falling snow, waves on the sea, and trees swaying by wind. • Areas which do not require detection are not set to OFF. • Detection level and detection standby time settings are not appropriate. • Scenes with constantly changing brightness, such as fluorescent lamp flickering and abrupt changes in weather or lighting, are selected.
<ul style="list-style-type: none"> • Motion Detection function does not operate. 	<ul style="list-style-type: none"> • Areas to be detected are not set to ON. • Detection level and detection standby time settings are not appropriate. • A time interval of approximately 15 seconds has not yet elapsed since the power was turned on. The Motion Detection alarm function does not operate for 15 seconds after the power is turned on.

26. SPECIFICATIONS

[C-MS161D]

Model No.	C-MS161D
Power Source	NTSC : 110 – 120 V AC, 50/60 Hz PAL : 220 – 240 V AC, 50/60 Hz
Power Consumption	NTSC : 18 W (320 mA) PAL : 20 W (220 mA)
Video Input	Camera input: 16 channels, VBS1.0 V(p-p), 75 Ω, BNC, 2:1 interlace*1 VCR input : 2 channels, VBS 1.0 V(p-p), 75 Ω, BNC
Video Output	Camera output : 16 channels, VBS1.0 V(p-p), 75 Ω, BNC, loop-through output Monitor output : 2 channels (Either channel can be set as spot output), VBS 1.0 V(p-p), 75 Ω, BNC VCR output : 2 channels, VBS 1.0 V(p-p), 75 Ω, BNC
Alarm	
Alarm Input	16 channels, no-voltage make contact input, open voltage: 5 VDC, short circuit current : 5 mA, D-sub connector (25 pins), make/break selectable on the menu
Alarm Output	1 channel, NPN open collector output, withstand voltage : 20 VDC, control current : under 20 mA, D-sub connector (25 pins)
Video Loss Alarm Output	1 channel, NPN open collector output, withstand voltage : 20 VDC, control current : under 20 mA, D-sub connector (25 pins)
Alarm Hold Output	1 channel, NPN open collector output, withstand voltage : 20 VDC, control current : under 20 mA, D-sub connector (25 pins)
Alarm Cancel Output	1 channel, NPN open collector output, withstand voltage : 20 VDC, control current : under 20 mA, D-sub connector (25 pins)
Motion Detection Output	1 channel, NPN open collector output, withstand voltage : 20 VDC, control current : under 20 mA, D-sub connector (25 pins)
Alarm Time	MANUAL, 10 s, 15 s, 20 s, 30 s, 1 – 5 min (adjustable in 1 minute steps), infinite
Buzzer	ON or OFF (selectable)
Remote	Remote Input : 12 channels (binary input: 6 channels), no-voltage make contact input, open voltage: 5 VDC, short circuit current : 5 mA, D-sub connector (25 pins) Remote Output : 10 channels (binary output: 6 channels), NPN open collector output, withstand voltage: 20 VDC, control current : under 20 mA, D-sub connector (25 pins)
Other Function	Motion detection, selection of the motion detection pattern, key lock, automatic recognition on time-lapse recording, selection of the recoding pattern, selection of the language (English/Spanish/French)
VCR Control	
Switcher control input	2 channels, no-voltage make contact input, open voltage: 5 VDC, short circuit current: under 0.3 mA, screwless connector
Alarm output	2 channels, NPN open collector output, withstand voltage: 20 VDC, control current: under 20 mA, screwless connector
Alarm cancel output	2 channels, NPN open collector output, withstand voltage: 20 VDC, control current: under 20 mA, screwless connector
Audio	VCR input : 2 channels, -10 dB*2, 50 kΩ or more, RCA pin jack Monitor output : 1 channel, -10 dB*2, low impedance, RCA pin jack
External Control	RS-232C : 1 channel, D-sub connector (9 pins, male) Remote control terminal : 1 each of input and output, screwless connector
Dedicated Remote Controller	Controllable by the optional C-RM100 (option) and C-RM500 (option) dedicated remote controllers
Recording Output	Minimum 1 frame interval

*1 That line-locked cameras cannot be connected

*2 0dB=1V

Model No.	C-MS161D
Screen Display	
Camera screen	Full screen selection : Selection of the desired camera Multi-split screen : 4-, 9-, 10- and 16-segment screen (intermittent display, arrangements in split screens changeable) Zoom : Electronic 2x zoom for the desired camera (zooming position changeable, automatic pan/tilt possible) Freeze : Freeze screen for individual cameras Automatic sequence : Full screen (individual cameras), 4-segment screen (camera groups), switching time intervals 0 – 99 seconds that can be set in 1 second units
VCR reproduction screen	Full screen selection : Selection of the desired camera Multi-split screen : 4-, 9- and 16-segment screen Zoom : Electronic 2x zoom for the desired camera (zooming position changeable, automatic pan/tilt possible) Freeze : Freeze screen for individual cameras
Spot screen	Full screen selection : Selection of the desired camera Automatic sequence : Full screen (individual cameras), switching time intervals 0 –99 seconds that can be set in 1 second units
Indication	Camera title : Up to 8 characters (alphanumeric and symbols). Camera No. and time/date can be displayed.
Number of Effective Pixels	NTSC : 720 x 464 pixels PAL : 720 x 552 pixels
Operating Temperature	0 °C to + 40 °C
Finish	Panel : Aluminum extrusion, black, 30% gloss Case : Surface-treated steel plate, black, 30% gloss, paint
Dimensions	420 (W) x 96.6 (H) x 333.9 (D) mm
Weight	4.3 kg

The Multi-Switcher's specifications are subject to change without notice.

[C-MS91D]

Model No.	C-MS91D
Power Source	NTSC : 110 – 120 V AC, 50/60 Hz PAL : 220 – 240 V AC, 50/60 Hz
Power Consumption	NTSC : 17 W (290 mA) PAL : 18 W (200 mA)
Video Input	Camera input : 9 channels, VBS1.0 V(p-p), 75 Ω, BNC, 2:1 interlace*1 VCR input : 2 channels, VBS 1.0 V(p-p), 75 Ω, BNC
Video Output	Camera output : 9 channels, VBS1.0 V(p-p), 75 Ω, BNC, loop-through output Monitor output : 2 channels (Either channel can be set as spot output), VBS 1.0 V(p-p), 75 Ω, BNC VCR output : 2 channels, VBS 1.0 V(p-p), 75 Ω, BNC
Alarm	
Alarm Input	9 channels, no-voltage make contact input, open voltage: 5 VDC, short circuit current : 5 mA, D-sub connector (25 pins), make/break selectable on the menu
Alarm Output	1 channel, NPN open collector output, withstand voltage : 20 VDC, control current : under 20 mA, D-sub connector (25 pins)
Video Loss Alarm Output	1 channel, NPN open collector output, withstand voltage : 20 VDC, control current : under 20 mA, D-sub connector (25 pins)
Alarm Hold Output	1 channel, NPN open collector output, withstand voltage : 20 VDC, control current : under 20 mA, D-sub connector (25 pins)
Alarm Cancel Output	1 channel, NPN open collector output, withstand voltage : 20 VDC, control current : under 20 mA, D-sub connector (25 pins)
Motion Detection Output	1 channel, NPN open collector output, withstand voltage : 20 VDC, control current : under 20 mA, D-sub connector (25 pins)
Alarm Time	MANUAL, 10 s, 15 s, 20 s, 30 s, 1 – 5 min (adjustable in 1 minute steps), infinite
Buzzer	ON or OFF (selectable)
Remote	Remote Input : 12 channels (binary input: 6 channels), no-voltage make contact input, open voltage: 5 VDC, short circuit current : 5 mA, D-sub connector (25 pins) Remote Output : 10 channels (binary output: 6 channels), NPN open collector output, withstand voltage: 20 VDC, control current : under 20 mA, D-sub connector (25 pins)
Other Function	Motion detection, selection of the motion detection pattern, key lock, automatic recognition on time-lapse recording, selection of the recoding pattern, selection of the language (English/Spanish/French)
VCR Control	
Switcher control input	2 channels, no-voltage make contact input, open voltage: 5 VDC, short circuit current: under 0.3 mA, screwless connector
Alarm output	2 channels, NPN open collector output, withstand voltage: 20 VDC, control current: under 20 mA, screwless connector
Alarm cancel output	2 channels, NPN open collector output, withstand voltage: 20 VDC, control current: under 20 mA, screwless connector
Audio	VCR input : 2 channels, -10 dB*2, 50 kΩ or more, RCA pin jack Monitor output : 1 channel, -10 dB*2, low impedance, RCA pin jack
External Control	RS-232C : 1 channel, D-sub connector (9 pins, male) Remote control terminal : 1 each of input and output, screwless connector
Dedicated Remote Controller	Controllable by the optional C-RM100 (option) and C-RM500 (option) dedicated remote controllers
Recording Output	Minimum 1 frame interval

*1 That line-locked cameras cannot be connected

*2 0dB=1V

Model No.	C-MS91D
Screen Display	
Camera screen	Full screen selection : Selection of the desired camera Multi-split screen : 4-, 9-, and 10-segment screen (intermittent display, arrangements in split screens changeable) Zoom : Electronic 2x zoom for the desired camera (zooming position changeable, automatic pan/tilt possible) Freeze : Freeze screen for individual cameras Automatic sequence : Full screen (individual cameras), 4-segment screen (camera groups), switching time intervals 0 – 99 seconds that can be set in 1 second units
VCR reproduction screen	Full screen selection : Selection of the desired camera Multi-split screen : 4-, and 9-segment screen Zoom : Electronic 2x zoom for the desired camera (zooming position changeable, automatic pan/tilt possible) Freeze : Freeze screen for individual cameras
Spot screen	Full screen selection : Selection of the desired camera Automatic sequence : Full screen (individual cameras), switching time intervals 0 –99 seconds that can be set in 1 second units
Indication	Camera title : Up to 8 characters (alphanumeric and symbols). Camea No. and time/date can be displayed.
Number of Effective Pixels	NTSC : 720 x 464 pixels PAL : 720 x 552 pixels
Operating Temperature	0 °C to + 40 °C
Finish	Panel : Aluminum extrusion, black, 30% gloss Case : Surface-treated steel plate, black, 30% gloss, paint
Dimensions	420 (W) x 51.8 (H) x 334.1 (D) mm
Weight	3.5 kg

The Multi-Switcher's specifications are subject to change without notice.

26.1. Accessories

Power cord (2 m) 1

26.2. Optional Equipment

[When using the C-MS91D]

MB-15B Rack Mounting Bracket

[When using the C-MS161D]

MB-23B Rack Mounting Bracket