

BG-2035/2060/2120 Mixer Amplifier



DESCRIPTION

TOA's BG-2000 Series reflects user demands for affordable, performance-focused mixer-amplifiers optimized for BGM applications. These units provide 5 mixer inputs (incl. a slot for an optional input module), making them ideal for use in retail stores, schools and restaurants, delivering satisfactory power output and the reliable, high-performance audio that TOA has earned its reputation for.

Designed for easy installation and maintenance, these tough, rack-mountable units are fitted with removable terminal blocks and rear panel-mounted DIP switches. This allows quick system installation and configuration changes. An input assignable MOH/ZONE 2 OUT provides system expansion capability for a 2-zone broadcast if required. The BG-2000 Series features the total reliability that TOA builds into its products, these compact and attractively priced amplifiers make it easy to offer BGM wherever desired.

FEATURES

- Compact five channel Mixer-Amplifier for paging, background/foreground music distribution and music/messaging-on-hold.
- All inputs/outputs with removable terminal blocks allow quick and easy installation.
- Any of five inputs assignable to MOH/ZONE 2 output.
- RCA pin jacks for LINES 2 & 3.
- Phantom Power (+ 24V DC) incorporated for MIC input.
- Module slot accepts 900 Series input plug-in modules for custom system configurations.
- Rear panel-mounted DIP switches allow easy configuring of settings.
- Provides auto/manual mute function with adjustable muting sensitivity.
- Incorporates Remote volume control connection.
- 2-channel broadcast capability together with zone 2 expansion capability in conjunction with BA-200 Series.
- Tamper-proof, front-panel bass and treble controls are recessed to protect their settings.
- Thermal protection circuitry prevents potential damage from excessive heat build-up.
- AC Mains Circuit Breaker.
- Accessory security knobs for volume control prevent unauthorized volume setting changes.
- Optional rack-mount kit.
- UL/cUL Listed.
- Five Year Warranty.

APPEARANCE AND DIMENSIONAL DIAGRAM

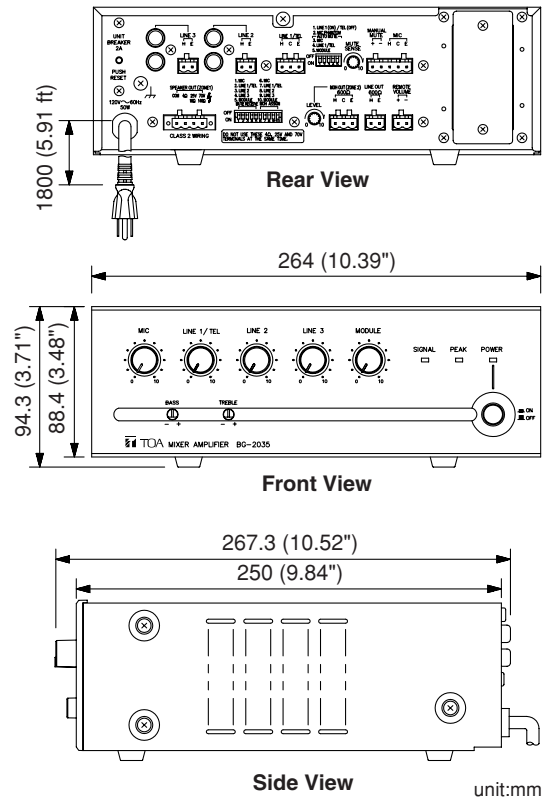

SPECIFICATIONS

Model No.	BG-2035		BG-2060		BG-2120		
Power Source	120 V AC, 60 Hz						
Rated Output	35 W		60 W		120 W		
Power Consumption	94 W (rated output), 50 W (based on cULus standards)		163 W (rated output), 80 W (based on cULus standards)		265 W (rated output), 120 W (based on cULus standards)		
Frequency Response	50 Hz – 20k Hz						
Total Harmonic Distortion	0.5% or less, at 1 kHz, rated output						
Input	Mic: -60dB*, 600Ω, electronically balanced, removable terminal block Line 1: -10 dB*/TEL: -20 dB* Line 1/TEL: selectable, 10kΩ, electronically balanced, removable terminal block Line 2, 3: -10 dB*, 10 kΩ, unbalanced, removable terminal block or RCA jack Module						
Output	Speaker	4 Ω, 25 V (), 70 V (140Ω) balanced, removable terminal block		4 Ω, 25 V (10Ω), 70 V (83Ω) balanced, removable terminal block		4 Ω, 25 V (5.2Ω), 70 V (42Ω) balanced, removable terminal block	
	MOH	0 dB*, 600 Ω, balanced, removable terminal block					
	Line	0 dB*, 600 Ω, unbalanced, removable terminal block					
Output Regulation	2 dB or less, no load to full load (1k Hz)						
Phantom Power	On/Off switch for Mic,+24V DC						
S/N Ratio	Mic: 60 dB or more, Line 1/TEL, Line 2, 3, Module: 75 dB or more (Band Pass: 20 Hz – 20 kHz, Tone Controls: Centered)						
Tone Control	Bass: ±10 dB at 100 Hz, Treble: ±10 dB at 10k Hz						
Muting	Manual mute/Automatic mute						
Control	Mic gain control, Line 1/TEL gain control, Line 2 gain control, Line 3 gain control, Module: gain control, Bass tone control, Treble tone control, MOH out gain control, Mute control (Manual mute), Remote volume control, Mute sense control, Line 1/TEL selector switch, Phantom power switch (Mic), Auto mute switch (Mic, Line 1/TEL, Module), Mute receive switch (Mic, Line 1/TEL, Line 2, 3, Module), MOH assign switch (Mic, Line 1/TEL, Line 2, 3, Module), Power ON/OFF switch						
Indicator	Power LED, Signal level LED, Peak LED						
Operating Temperature	0°C to 40 °C (32°F to 104 °F)						
Operating Humidity	35 % to 80 % RH (no condensation)						
Finish	Panel: ABS resin, black/Case: Steel plate, black, paint						
Dimensions	264 (W) × 94.3 (H) × 267.3 (D)mm (10.39" × 3.71" × 10.52")						
Weight	5.3 kg (11.68 lb)		5.3 kg (11.68 lb)		6 kg (13.23 lb)		
Accessory	Volume control cover: YA-920 × 5, Removable terminal plug (2 pins) × 4, Removable terminal plug (3 pins) × 2, Removable terminal plug (4 pins) × 1, Removable terminal plug (5 pins) × 1						
Option	Rack mounting brackets: MB-1000						

*0dB = 1V

CHARACTERISTIC DIAGRAMS

BG-2035

THD vs Power Output

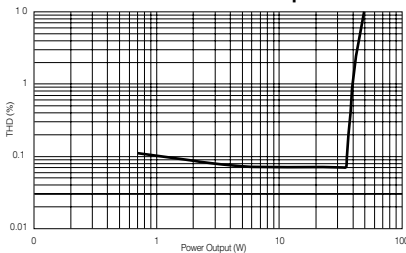

Frequency Response

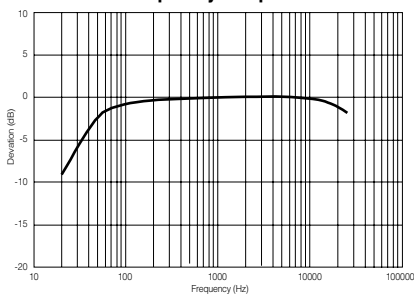

BG-2060

THD vs Power Output

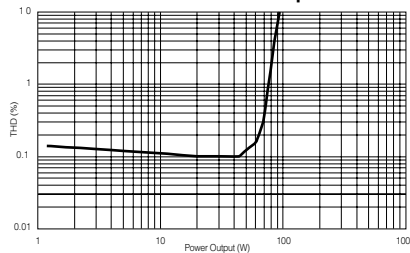

Frequency Response

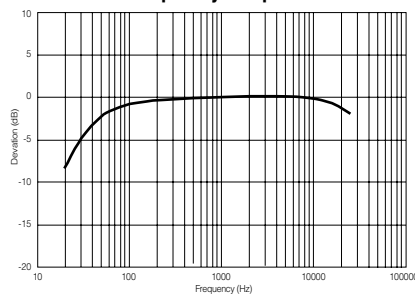

BG-2120

THD vs Power Output

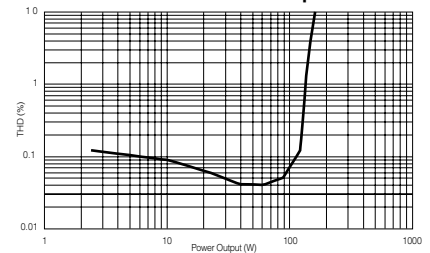

Frequency Response

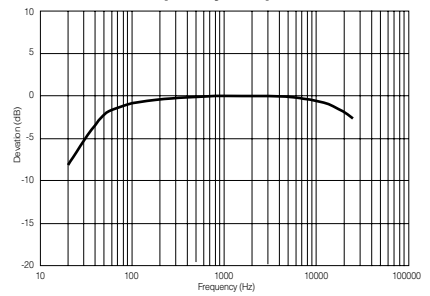

Measurement: Line 3 input

ARCHITECTURAL AND ENGINEERING SPECIFICATIONS

The mixer amplifier shall control and mix up to five input signals and deliver an audio output of 35W/60W/120W. Frequency response shall be 50 to 20k Hz with 0.5% or less THD at rated output. The output regulation shall be 2dB or less, no load to full load. Mixer inputs shall include four built-in inputs: Mic, Line 1/TEL, Line 2, Line 3 and one modular input, compatible with TOA plug-in modules.

The Mic input shall be electronically balanced with -60dBV sensitivity, 600 ohm input impedance, switchable phantom power (+24V DC) and removable terminal block connection. The switch-selectable Line 1/TEL input shall be electronically balanced with -10dBV (Line 1) / -20dBV (TEL) sensitivity, 10k ohm input impedance and removable terminal block connection. Line 2 and Line 3 inputs shall be unbalanced with -10dBV sensitivity, 10k ohm input impedance, removable terminal block connection and RCA pin jacks. The modular input shall be compatible with TOA plug-in modules. The mixer amplifier shall include 25V, 70V and 4 ohm balanced outputs with removable terminal block connections.

The mixer amplifier shall include a MOH/ZONE 2 output with 0dBV sensitivity, 600 ohm output impedance and removable terminal block connection. Each input shall be assignable to the MOH/ZONE 2 output. 2-channel broadcast shall be possible using the MOH/ZONE 2 output. The Line output shall be unbalanced with 0 dBV sensitivity, 600 ohm output impedance and removable terminal block connection.

The mixer amplifier shall incorporate manual mute and auto-mute function. Manual mute function shall allow any input placed in mute receive mode when the

manual mute terminal is short-circuited. Auto-mute function shall allow input signal to Mic., Line 1/TEL and Module input to override the inputs set to be muted, without interrupting the MOH/ZONE 2 output. Rear-mounted DIP switches shall allow assignment of all inputs to respond to the mute function activation. A rear-mounted MUTE SENSE control shall allow threshold adjustment of mute activation. 2-channel broadcast shall be possible by connecting the MOH/ZONE 2 output of BG-2000 Series to the unit's LINE input.

Built-in protection circuitry shall monitor current level to minimize potential damage from overloads, and disable output during excessive operating temperature over 221°F (105°C). Recessed Bass and Treble controls shall be located on the front panel. Accessory volume control security knob shall be included to prevent the accidental change of input volume settings.

The mixer amplifier shall be cULus-Listed and capable of operation from a 120V AC / 60Hz line breaker. Dimensions (W x H x D) shall be 10.39" x 3.71" x 10.52" (264 x 94.3 x 267.3 mm). Net weight shall be BG-2035/2060: 11.68 lbs. (5.3kg); BG-2120: 13.23 lbs. (6kg). Front panel finish and material shall be black ABS resin and case finish (and material) shall be black steel plate.

The mixer amplifier shall be TOA model BG-2035 / BG-2060 / BG-2120.

The optional rack-mount bracket shall be TOA model MB-1000.

The volume control security knob shall be TOA model YA-920.

BLOCK DIAGRAM

