

BG-220/235/BA-235/260 PA Amplifier

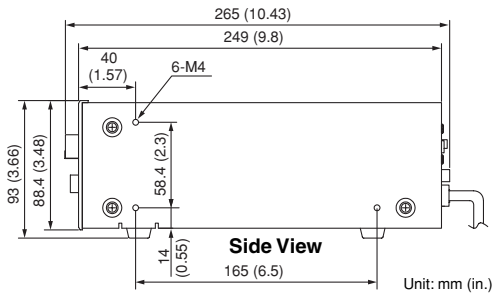

APPEARANCE AND DIMENSIONAL DIAGRAM

BG-220/235

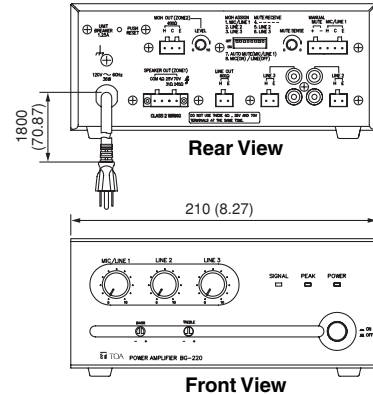

BA-235/260

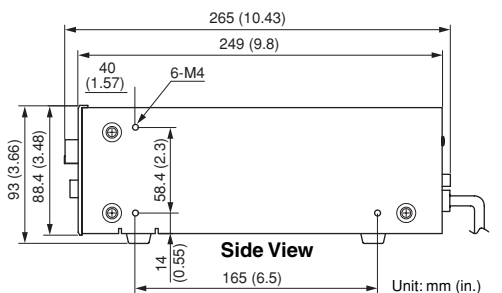
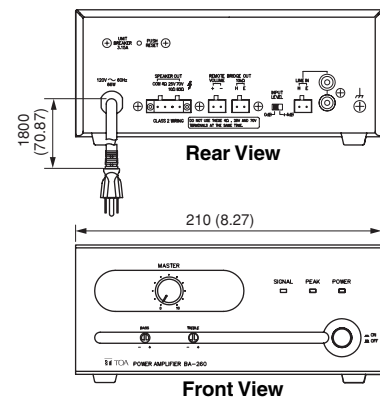

DESCRIPTION

Designed to satisfy users' specific requirements for the BGM market, the compact TOA BG and BA Series of mixer amplifiers are ideal for use in banquet rooms, bars and retail outlets, delivering satisfactory power output as well as the reliable audio performance and features that TOA is known for.

The BG-220 and BG-235 units are each equipped with 1 Mic/Line input and 2 Line inputs and also include an MOH Out. For installation ease, the rear-mounted terminal blocks are removable. DIP switches are provided to enable quick settings. A ZONE 2 OUT provides system expansion capability when needed.

Users' BGM market demands include affordable, mixer amplifiers optimized for simpler applications that will not require paging and/or MOH Out features. The new BA-235 and BA-260 power amplifiers are ideal solutions, delivering high-quality audio performance and generous power.

A wider scope of operation can be gained by combining BG and BA to achieve full 2-channel broadcasts. The compact and attractively priced BG and BA Series make it easy to provide ideal BGM services wherever desired as well as help to reduce system costs due to the significantly less time required for system installation and set-up.

FEATURES

- Affordable and compact amplifiers designed for background music and paging applications.
- Ideal for mid-sized environments including bars, retail outlets, classrooms, restaurants etc.
- 2-channel broadcasts possible for system expansion as needed through MOH/ZONE 2 output on BG Series amplifiers
- Tamper-proof bass and treble controls preserve system settings.
- Security knobs for volume control included.
- Thermal protection circuits against overheating.
- Meets UL/cUL regulations.

BG-200 Series

- Any of 3 inputs can be assigned to MOH/ZONE 2 output.
- LINE 2/3 outputs equipped with RCA pin jacks.
- Automatic Mute sensing control to set mute activation threshold and manual mute function.
- Removable terminal blocks and rear-mounted DIP switches for fast and easy installation/setup.

BA-200 Series

- Remote master volume control possible by using an external volume control.
- RCA line input jacks.



SPECIFICATIONS

Model No.	BG-220		BG-235	
Power Source	120 V AC, 60 Hz			
Rated Output	20 W		35 W	
Power Consumption	60 W (rated output), 36 W (based on cULus standards)		90 W (rated output), 55 W (based on cULus standards)	
Frequency Response	50 Hz – 20k Hz			
Total Harmonic Distortion	0.5% or less, at 1 kHz, rated output			
Input	Mic.: -60 dB*/Line 1: -10 dB* Mic/Line 1 selectable, 600Ω, electronically balanced, removable terminal block Line 2, 3: -10 dB*, 10 kΩ, unbalanced, removable terminal block or RCA jack			
Output	Speaker	4 Ω, 25 V (31 Ω) and 70 V (245 Ω) balanced, removable terminal block		4 Ω, 25 V (18 Ω) and 70 V (140 Ω) balanced, removable terminal block
	MOH	0 dB*, 600 Ω, balanced, removable terminal block		
	Line	0 dB*, 600 Ω, unbalanced, removable terminal block		
Output Regulation	2 dB or less, no load to full load (1k Hz)			
S/N Ratio	Mic/Line 1: 60 dB or more/Line 2, 3: 80 dB or more (Band Pass: 20 Hz – 20k Hz, Tone Controls: Centered)			
Tone Control	Bass: ±10 dB at 100 Hz, Treble: ±10 dB at 10k Hz			
Control	Mic/Line 1 gain control, Line 2 gain control, Line 3 gain control, Bass tone control, Treble tone control, MOH out gain control, Mute control (Manual mute), Mute sense control, Auto mute switch (Mic/Line 1), Mic /Line 1 selector switch, Mute receive switch (Line 2, 3), MOH assign switch (Mic/Line 1, Line 2, 3), Power ON/OFF switch			
Indicator	Power LED, Signal level LED, Peak LED			
Other Feature	Automatic electronic drive limiter			
Operating Temperature	0°C to 40 °C (32°F to 104 °F)			
Operating Humidity	35 % to 80 % RH (no condensation)			
Finish	Panel: ABS resin, black/Case: Steel plate, black, paint			
Dimensions	210 (W) × 94.3 (H) × 265 (D)mm (8.27" × 3.71" × 10.43")			
Weight	3.5 kg (7.72 lb)		4 kg (8.82 lb)	
Accessory	Volume control cover: YA-920 × 3, Removable terminal plug (2 pins) × 3, Removable terminal plug (3 pins) × 1, Removable terminal plug (4 pins) × 1, Removable terminal plug (5 pins) × 1			
Option	Rack mounting brackets: MB-25B-BK, MB-25B-J			

*0dB = 1V

CHARACTERISTIC DIAGRAMS

BG-220

THD vs Power Output

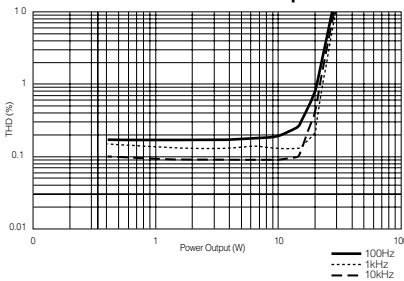

Frequency Response

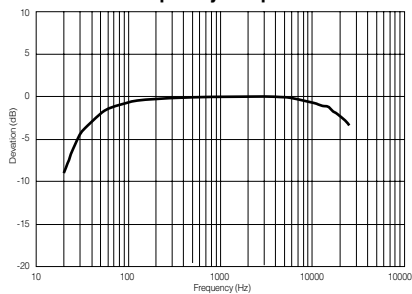

BG-235

THD vs Power Output

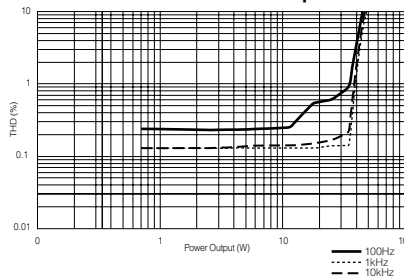

Frequency Response

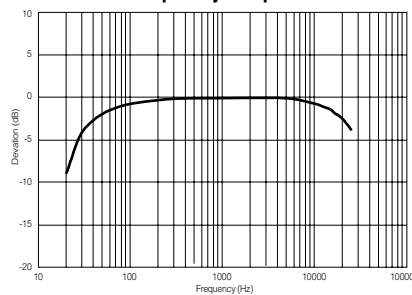

Measurement: Line 2 input

ARCHITECTURAL AND ENGINEERING SPECIFICATIONS

BG-220 / BG-235

The mixer amplifier shall control and mix up to three input signals and deliver an audio output of 20W/35W. Frequency response shall be 50 to 20k Hz with 0.5% or less THD at rated output. The output regulation shall be less than 2dB, no load to full load. The mixer amplifier shall have switch-selectable MIC/LINE input, electronically balanced, with removable terminal block connections and two LINE inputs, unbalanced, with removable terminal block connections and RCA jacks. The MIC/LINE 1 input impedance shall be 600 ohms and the LINE 2/3 input impedance shall be 10k ohms. The mixer amplifier shall include a MOH/ZONE 2 output with removable terminal block. The mixer amplifier shall include 25V, 70V and 4 ohm balanced outputs. Built-in protection circuitry shall monitor current level to minimize potential damage from overloads, and disable output during excessive operating temperature over 221°F (105°C). The mixer amplifier shall incorporate a mute function to allow MIC/LINE input to override LINE 2 and 3 input without interrupting the MOH/ZONE 2 output. A rear-mounted MUTE SENSE control shall allow threshold adjustment of mute activation. Terminals for activating the mute function manually with external switch closure shall also be included. Rear-mounted DIP switches shall allow assignment of LINE 2 and/or LINE 3 to respond to the mute function activation. Each input shall be assignable to the MOH/ZONE 2 output. 2-channel broadcast shall be possible using the MOH/ZONE 2 output. Recessed Bass and Treble controls shall be located on the front panel. Accessory volume control security knob shall be included to prevent the accidental change of input volume settings.

The mixer amplifier shall be cULus-Listed and capable of operation from a 120V AC / 60Hz line breaker. Dimensions (W × H × D) shall be 8.27" × 3.71" × 10.43" (210 × 94.3 × 265 mm). Net weight shall be BG-220: 7.72 lbs. (3.5kg); BG-235: 8.82 lbs. (4kg). Front panel finish and material shall be black ABS resin and case finish (and material) shall be black steel plate.

The mixer amplifier shall be TOA model BG-220 / BG-235. The optional rack-mount bracket shall be TOA model MB-25B-BK. The optional rack-mount bracket (two units) shall be TOA model MB-25B-J.

SPECIFICATIONS

Model No.	BA-235		BA-260	
Power Source	120 V AC, 60 Hz			
Rated Output	35 W		60 W	
Power Consumption	90 W (rated output), 52 W (based on cULus standards)		130 W (rated output), 66 W (based on cULus standards)	
Frequency Response	50 Hz – 20k Hz			
Total Harmonic Distortion	0.5% or less, at 1k Hz, rated output			
Input	Line input: 0 dB*/+4 dB* (selectable), 10k Ω , unbalanced, removable terminal block or RCA jack			
Output	Speaker 4 Ω , 25 V (18 Ω) and 70 V (140 Ω), balanced, removable terminal block		Bridge 4 Ω , 25 V (10 Ω) and 70 V (83 Ω) balanced, removable terminal block	
Output Regulation (1 kHz)	Parallel in Line input, removable terminal block 2 dB or less, no load to full load (1k Hz)			
S/N Ratio	80 dB or more (Band Pass: 20 Hz – 20k Hz, Tone Controls: Centered)			
Tone Control	Bass: \pm 10 dB at 100 Hz, Treble: \pm 10 dB at 10k Hz			
Control	Master gain control, Bass tone control, Treble tone control, Input level selector switch, Remote Volume control, Power ON/OFF switch			
Indicator	Power LED, Signal level LED, Peak LED			
Other Feature	Automatic electronic drive limiter			
Operating Temperature	0°C to 40 °C (32°F to 104 °F)			
Operating Humidity	35 % to 80 % RH (no condensation)			
Finish	Panel: ABS resin, black/Case: Steel plate, black, paint			
Dimensions	210 (W) \times 94.3 (H) \times 265 (D)mm (8.27" \times 3.71" \times 10.43")			
Weight	4 kg (8.82 lb)		4.6 kg (10.14 lb)	
Accessory	Volume control cover: YA-920 \times 1, Removable terminal plug (2 pins) \times 3, Removable terminal plug (4 pins) \times 1			
Option	Rack mounting brackets: MB-25B-BK, MB-25B-J			

*0dB = 1V

CHARACTERISTIC DIAGRAMS

BA-235

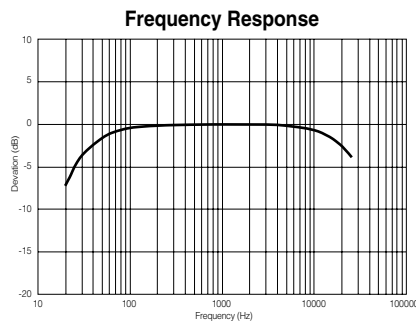
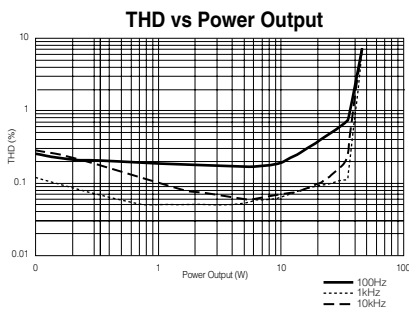

BA-260

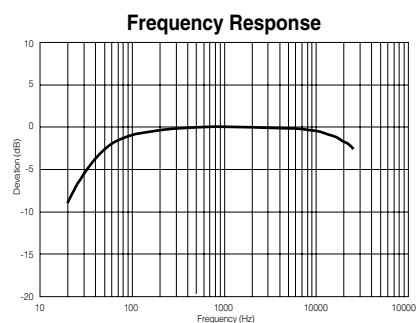
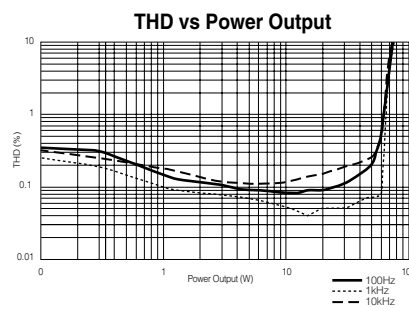

ARCHITECTURAL AND ENGINEERING SPECIFICATIONS

BA-235 / BA-260

The power amplifier shall control one line input signal and deliver an audio output of 35W/60W. Frequency response shall be 50 to 20k Hz with 0.5% or less THD at rated output. The output regulation shall be less than 2dB, no load to full load. The power amplifier shall have one LINE input, unbalanced, with removable terminal block connections as well as a pair of RCA jacks. The LINE input impedance shall be 10k ohms. Line input sensitivity level shall be selectable between 0 dB and +4 dB on the rear panel. The mixer amplifier shall include 25V, 70V and 4 ohm balanced outputs, with removable terminal block connection. Built-in protection circuitry shall monitor current level to minimize potential damage from overloads, and disable output during excessive operating temperature over 221°F (105°C). 2-channel broadcast shall be possible by connecting the MOH/ZONE 2 output of BG-200 Series to the unit's LINE input. Recessed Bass and Treble controls shall be located on the front panel. Accessory volume control security knob shall be included to prevent the accidental change of input volume settings. The power amplifier shall incorporate REMOTE VOLUME terminals for control with an external 10k ohm linear-taper potentiometer.

The power amplifier shall be cULus-Listed and capable of operation from a 120V AC / 60 Hz line breaker. Dimensions (W \times H \times D) shall be 8.27" \times 3.71" \times 10.43" (210 \times 94.3 \times 265 mm). Net weight shall be BA-235: 8.82 lbs. (4 kg); BA-260: 10.14 lbs. (4.6 kg). Front panel finish and material shall be black ABS resin and case finish (and material) shall be black steel plate.

The power amplifier shall be TOA model BA-235 / BA-260.

The optional rack-mount bracket shall be TOA model MB-25B-BK.

The optional rack-mount bracket (two units) shall be TOA model MB-25B-J.

BLOCK DIAGRAM

BG-220/235

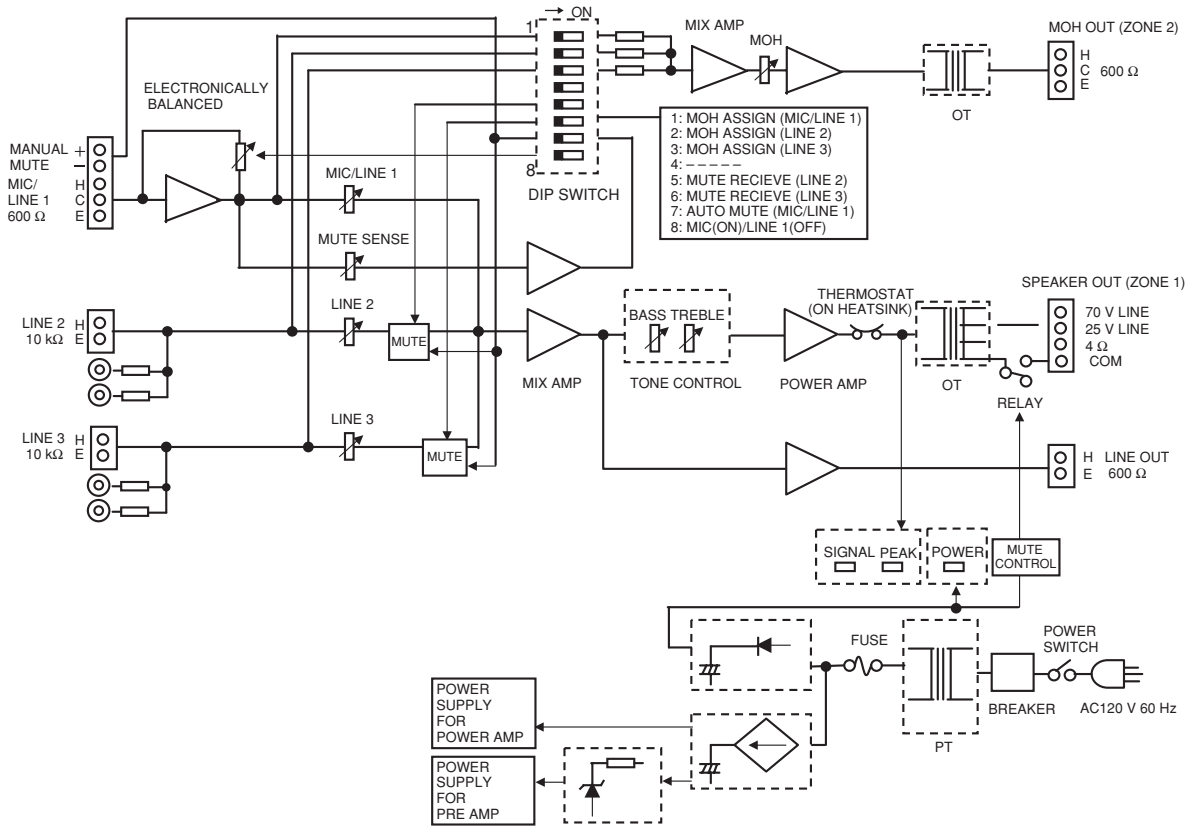

BA-235/260

