

STEREO MIXER

M-243

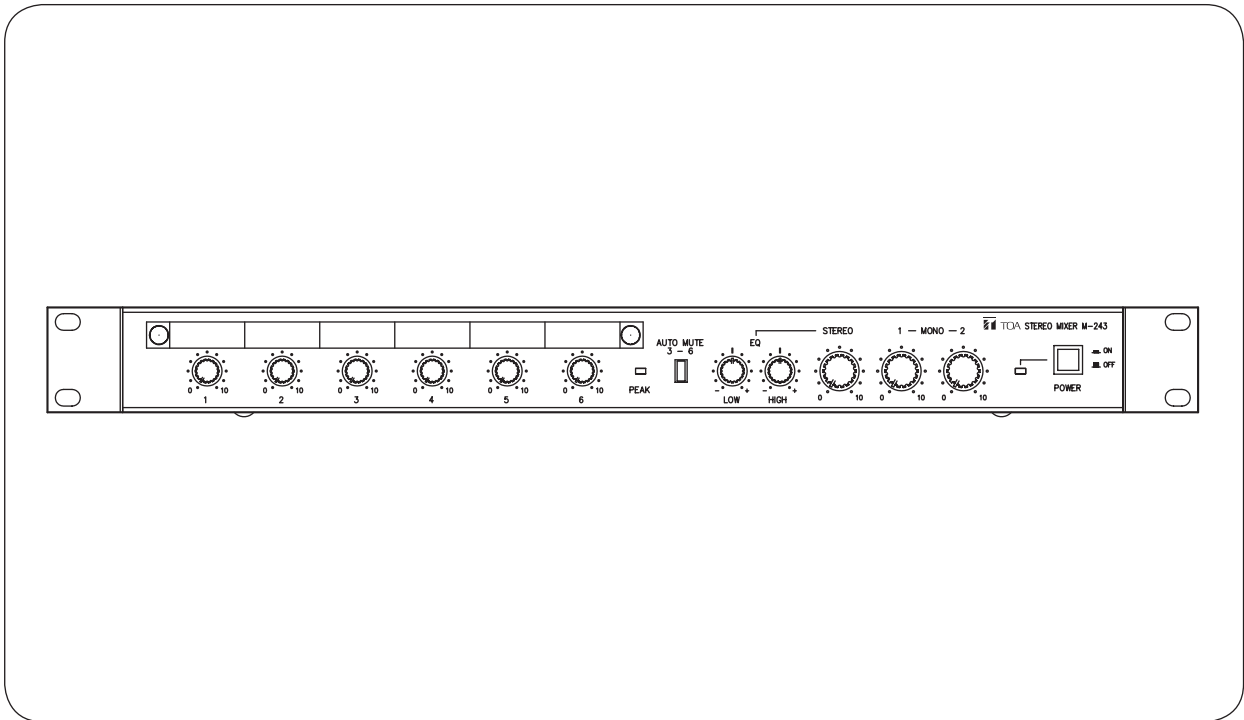

TABLE OF CONTENTS

1. IMPORTANT SAFETY INSTRUCTIONS	2	6. INTERNAL SWITCH SETTINGS	6
2. SAFETY PRECAUTIONS	3	7. BLOCK AND LEVEL DIAGRAMS	7
3. GENERAL DESCRIPTION	4	8. DIMENSIONAL DIAGRAM	7
4. FEATURES	4	9. SPECIFICATIONS	8
5. NOMENCLATURE AND FUNCTIONS	5	Accessories	8
Front	5		
Rear	6		

Thank you for purchasing TOA's Stereo Mixer.  
Please carefully follow the instructions in this manual to ensure long, trouble-free use of your equipment.

# 1. IMPORTANT SAFETY INSTRUCTIONS

- Read these instructions.
- Keep these instructions.
- Heed all warnings.
- Follow all instructions.
- Do not use this apparatus near water.
- Clean only with dry cloth.
- Do not block any ventilation openings. Install in accordance with the manufacturer's instructions.
- Do not install near any heat sources such as radiators, heat registers, stoves, or other apparatus (including amplifiers) that produce heat.
- Do not defeat the safety purpose of the polarized or grounding-type plug. A polarized plug has two blades with one wider than the other. A grounding type plug has two blades and a third grounding prong. The wide blade or the third prong are provided for your safety. If the provided plug does not fit into your outlet, consult an electrician for replacement of the obsolete outlet.
- Protect the power cord from being walked on or pinched particularly at plugs, convenience receptacles, and the point where they exit from the apparatus.
- Only use attachments/accessories specified by the manufacturer.
- Use only with the cart, stand, tripod, bracket, or table specified by the manufacturer, or sold with the apparatus. When a cart is used, use caution when moving the cart/apparatus combination to avoid injury from tip-over.
- Unplug this apparatus during lightning storms or when unused for long periods of time.
- Refer all servicing to qualified service personnel. Servicing is required when the apparatus has been damaged in any way, such as power-supply cord or plug is damaged, liquid has been spilled or objects have fallen into the apparatus, the apparatus has been exposed to rain or moisture, does not operate normally, or has been dropped.



## INSTRUCTIONS ESSENTIELLES POUR LA SÉCURITÉ

- Lire ces instructions.
- Conserver ces instructions pour référence ultérieure.
- Respecter tous les avertissements.
- Suivre toutes les instructions.
- Ne pas utiliser cet appareil à proximité d'eau.
- Nettoyer uniquement à l'aide d'un chiffon sec.
- Ne pas obstruer les orifices de ventilation. Installer conformément aux instructions du fabricant.
- Ne pas installer à proximité de sources de chaleur telles que des radiateurs, des registres thermiques, des chaudières ou d'autres appareils (notamment des amplificateurs) produisant de la chaleur.
- Ne pas contourner la fonction de sécurité de la fiche polarisée ou de mise à la terre. Une fiche polarisée est équipée de deux broches, dont l'une est plus large que l'autre. Une fiche de mise à la terre est équipée de deux broches et d'une troisième pour la mise à la terre. Cette dernière, la plus large, est prévue à des fins de sécurité. Si la fiche fournie ne peut être insérée dans la prise électrique souhaitée, consulter un électricien pour faire remplacer cette dernière.
- Protéger le cordon d'alimentation pour éviter qu'il ne soit piétiné ou pincé, notamment au niveau des fiches, des prises de courant ou de son point de sortie de l'appareil.
- Utiliser uniquement les accessoires spécifiés par le fabricant.
- Utiliser uniquement avec le chariot, support, trépied, la patte de montage ou la table spécifiés par le fabricant ou vendus avec l'appareil. En cas d'utilisation d'un chariot, manipuler la combinaison chariot/appareil pour éviter les blessures dues à un renversement.
- Débrancher cet appareil pendant les orages ainsi que lorsqu'il reste inutilisé pendant une période prolongée.
- La maintenance de l'appareil doit être confiée à un technicien après-vente qualifié. Une maintenance s'avère nécessaire si l'appareil est endommagé (au niveau du cordon d'alimentation ou de la fiche), a été mouillé par un liquide, un objet est tombé à l'intérieur, s'il a été exposé à la pluie ou l'humidité, s'il ne fonctionne pas normalement ou s'il est tombé.



## 2. SAFETY PRECAUTIONS

- Before installation or use, be sure to carefully read all the instructions in this section for correct and safe operation.
- Be sure to follow all the precautionary instructions in this section, which contain important warnings and/or cautions regarding safety.
- After reading, keep this manual handy for future reference.

### Safety Symbol and Message Conventions

Safety symbols and messages described below are used in this manual to prevent bodily injury and property damage which could result from mishandling. Before operating your product, read this manual first and understand the safety symbols and messages so you are thoroughly aware of the potential safety hazards.



**WARNING**

Indicates a potentially hazardous situation which, if mishandled, could result in death or serious personal injury.



**CAUTION**

Indicates a potentially hazardous situation which, if mishandled, could result in moderate or minor personal injury, and/or property damage.



**WARNING**



**AVERTISSEMENT**

#### When Installing the Unit

##### Lors de l'installation de l'appareil

- Do not expose the unit to rain or an environment where it may be splashed by water or other liquids, as doing so may result in fire or electric shock.
- Ne pas exposer l'appareil à la pluie et le protéger de tout contact avec de l'eau ou d'autres liquides afin d'éviter un incendie ou une électrocution.
- Use the unit only with the voltage specified on the unit. Using a voltage higher than that which is specified may result in fire or electric shock.
- Do not cut, kink, otherwise damage nor modify the power supply cord. In addition, avoid using the power cord in close proximity to heaters, and never place heavy objects -- including the unit itself -- on the power cord, as doing so may result in fire or electric shock.
- Since the unit is designed for in-door use, do not install it outdoors. When it gets wet with rain, there is a danger of electric shock.
- The apparatus shall be connected to a mains socket outlet with a protective earthing connection.
- The socket-outlet shall be installed near the equipment and the plug shall be easily accessible.

#### When the Unit is in Use

- Should the following irregularity be found during

use, immediately switch off the power, disconnect the power supply plug from the AC outlet and contact your nearest TOA dealer. Make no further attempt to operate the unit in this condition as this may cause fire or electric shock.

- If you detect smoke or a strange smell coming from the unit.
- If water or any metallic object gets into the unit
- If the unit falls, or the unit case breaks
- If the power supply cord is damaged (exposure of the core, disconnection, etc.)
- If it is malfunctioning (no tone sounds.)
- To prevent a fire or electric shock, never open nor remove the unit case as there are high voltage components inside the unit. Refer all servicing to qualified service personnel.
- Do not place cups, bowls, or other containers of liquid or metallic objects on top of the unit. If they accidentally spill into the unit, this may cause a fire or electric shock.
- Do not insert nor drop metallic objects or flammable materials in the ventilation slots of the unit's cover, as this may result in fire or electric shock.



**CAUTION**

#### When Installing the Unit

- Never plug in nor remove the power supply plug with wet hands, as doing so may cause electric shock.
- When unplugging the power supply cord, be sure to grasp the power supply plug; never pull on the cord

itself. Operating the unit with a damaged power supply cord may cause a fire or electric shock.

- When moving the unit, be sure to remove its power supply cord from the wall outlet. Moving the unit with the power cord connected to the outlet may cause damage to the power cord, resulting in fire or electric shock. When removing the power cord, be sure to hold its plug to pull.
- Avoid installing the unit in humid or dusty locations, in locations exposed to the direct sunlight, near the heaters, or in locations generating sooty smoke or steam as doing otherwise may result in fire or electric shock.
- Be sure to follow the instructions below when rack-mounting the unit. Failure to do so may cause a fire or personal injury.
  - Install the equipment rack on a stable, hard floor. Fix it with anchor bolts or take other arrangements

to prevent it from falling down.

- When connecting the unit's power cord to an AC outlet, use the AC outlet with current capacity allowable to the unit.
- The supplied rack-mounting screws can be used for the TOA equipment rack only. Do not use them for other racks.

#### When the Unit is in Use

- If dust accumulates on the power supply plug or in the wall AC outlet, a fire may result. Clean it periodically. In addition, insert the plug in the wall outlet securely.
- Switch off the power, and unplug the power supply plug from the AC outlet for safety purposes when cleaning or leaving the unit unused for 10 days or more. Doing otherwise may cause a fire or electric shock.



The lightning flash with arrowhead symbol, within an equilateral triangle, is intended to alert the user to the presence of uninsulated "dangerous voltage" within the product's enclosure that may be of sufficient magnitude to constitute a risk of electric shock to persons.



The exclamation point within an equilateral triangle is intended to alert the user to the presence of important operation and maintenance (servicing) instruction in the literature accompanying the appliance.



L'éclair accompagné d'un symbole représentant une pointe de flèche à l'intérieur d'un triangle équilatéral avertit l'utilisateur de la présence d'une "tension dangereuse" à l'intérieur de l'enceinte du téléviseur, dont la magnitude peut être suffisante pour constituer un risque de choc électrique pour les personnes.



Le point d'exclamation à l'intérieur d'un triangle équilatéral avertit l'utilisateur de l'existence d'instructions d'utilisation et d'entretien (réparation) dans la documentation fournie avec l'appareil.

### 3. GENERAL DESCRIPTION

The M-243 is a stereo mixer equipped with 2 monaural inputs, 4 stereo inputs, 1 stereo output, and 2 monaural outputs. It can be mounted in an EIA component rack (1U size\*).

\* 1U size = 44.5 mm or 1.75" (standard size)

## 4. FEATURES

- 2 monaural inputs, 4 stereo inputs, 1 stereo output, and 2 monaural outputs. Assignable each input signal to 3 output channels individually.
- Sub-input terminals for stereo output channel and each of 2 monaural output channels.
- Microphone input or line input for monaural input selectable depending on the signal level. Built-in limiter circuitry eliminates distortion under excessive input levels. High-pass filter as well as PAD (only for MIC input) in the monaural line available by the internal switch settings.
- Peak indicator to detect clipping.
- An "Automatic Muting" circuit automatically mutes the stereo output signal by detecting the monaural input signal. (ON/OFF switchable)
- A recording output and equalizer (high and low frequencies) for the stereo output channel.
- 2 channel monaural outputs usable as sum outputs for the stereo output channel individually by the internal switch setting.
- Protective cover for protecting the setting position of each input usable as a writing plate.
- Knobs supplied in different colors and size easily replaceable depending on the intended use, improving operability of the unit.

## 5. NOMENCLATURE AND FUNCTIONS

### [Front]

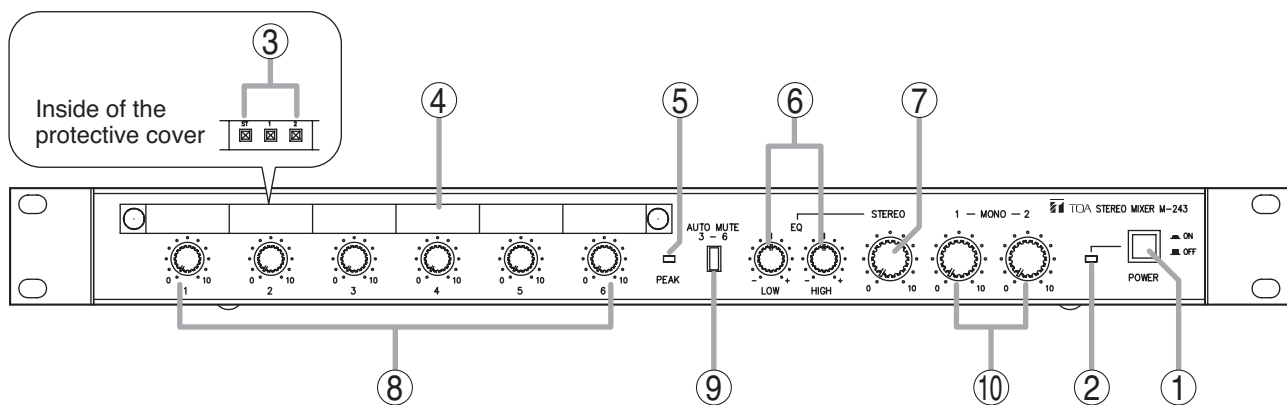

#### 1. Power switch

Power is switched on and off with each depression of this switch.

#### 2. Power indicator

Lights when the power switch is set to ON.

#### 3. Assignment keys [ST, 1, 2]

Select one of the following output destinations to which the post-fader input signals are routed. Signals are output when pressed.

- ST: Stereo output
- 1: MONO 1 output
- 2: MONO 2 output

#### 4. Protective cover

Used to protect the setting position of the assignment keys (3) from accidental operation. It can be used as a writing plate.

#### 5. Peak indicator

Lights when the output signal reaches 3 dB below clipping. Be sure to adjust each input level so that the Peak indicator does not light continuously.

#### 6. Equalizer controls [EQ: LOW & HIGH]

Adjust stereo output signal tone.

LOW: Low frequency adjustment (20 Hz,  $\pm 15$  dB shelving)

HIGH: High frequency adjustment (20 kHz,  $\pm 15$  dB shelving)

#### 7. Stereo output level control

Adjusts stereo output level.

#### 8. Input level controls [1 – 6]

(1 – 2: Monaural input, 3 – 6: Stereo input)

Adjust the input level of each channel.

#### 9. Mute key

Activates muting when pressed. (Indicator lights.)

#### [Muting function]

This function works only for the stereo output channels. Attenuates the signals applied to Channels 3 through 6 by detecting signals applied to Channel 1 or 2. (This function does not work for the monaural output signal.)

#### 10. Monaural output level controls

Adjust monaural output level.

**[Rear]**

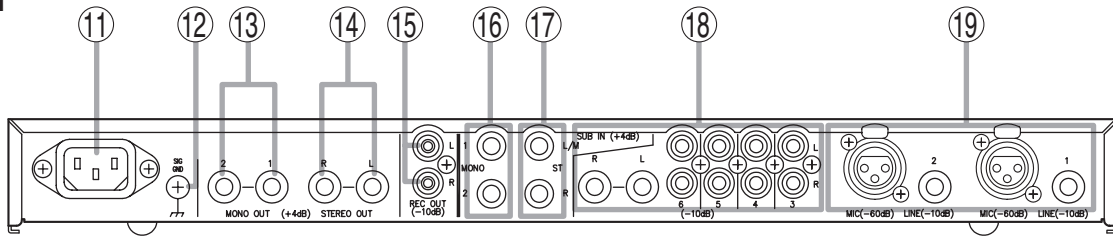

**11. AC inlet**

Connect the supplied power cord.

**12. Functional earth terminal**

Hum noise may be generated when external equipment is connected to the unit. Connecting this terminal to the functional earth terminal of the external equipment may reduce the hum noise.

**Note:** This terminal is not for protective earth.

**13. Monaural output jacks**

Function as sum output for the stereo output channel by the internal switch setting. (Refer to section "6. INTERNAL SWITCH SETTINGS.")

**14. Stereo output jacks**

**15. Recording output jacks**

Output the signal from the stereo output bus for recording.

**16. Monaural sub-input terminals**

Signals from these terminals are sent to each monaural output bus (Mono 1 and Mono 2).

**17. Stereo sub-input terminals**

Signals from these terminals are sent to stereo output bus. Connecting the signal to only "L" permits it to be input to both "L" and "R."

**18. Stereo input terminals (3 – 6)**

Only CH6's RCA jacks are internally connected in parallel to phone jacks.

**19. Monaural input terminals (1, 2)**

Select either MIC or LINE for connection. If both are connected, LINE input takes precedence.

**6. INTERNAL SWITCH SETTINGS**



**WARNING**

This work should only be performed by a qualified professional electrician. If users open the unit case or modify the unit, this may cause fire or electric shock.

The functions below can be made available by changing the switch settings inside the unit.

- (1) "PAD" switch: Set to the "IN" position to insert PAD (20 dB) in the monaural input (microphone input).
- (2) "HPF" switch: Set to the "IN" position to insert High pass filter (300 Hz, -6 dB/oct) in the monaural input.
- (3) "GND" switch: When the unit is connected to external equipment, a ground may create a loop, potentially generating a noise (hum). In such cases, set this switch to the LIFT position to cut off the ground loop.
- (4) "MONO1" and "MONO2" switches: Set to the "ST SUM" position to change each monaural output to stereo sum output for the stereo output channel.

**[Factory default setting]**

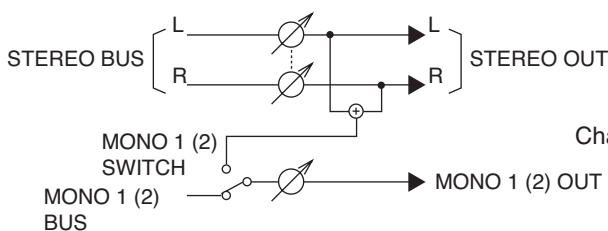

**[After the change]**

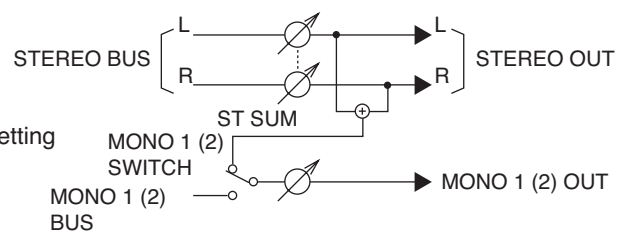

Change in setting

# 7. BLOCK AND LEVEL DIAGRAMS

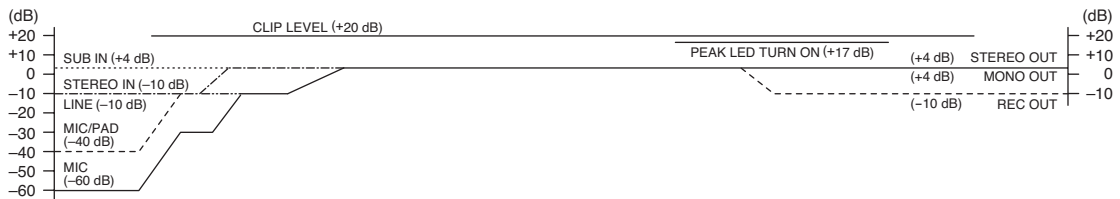
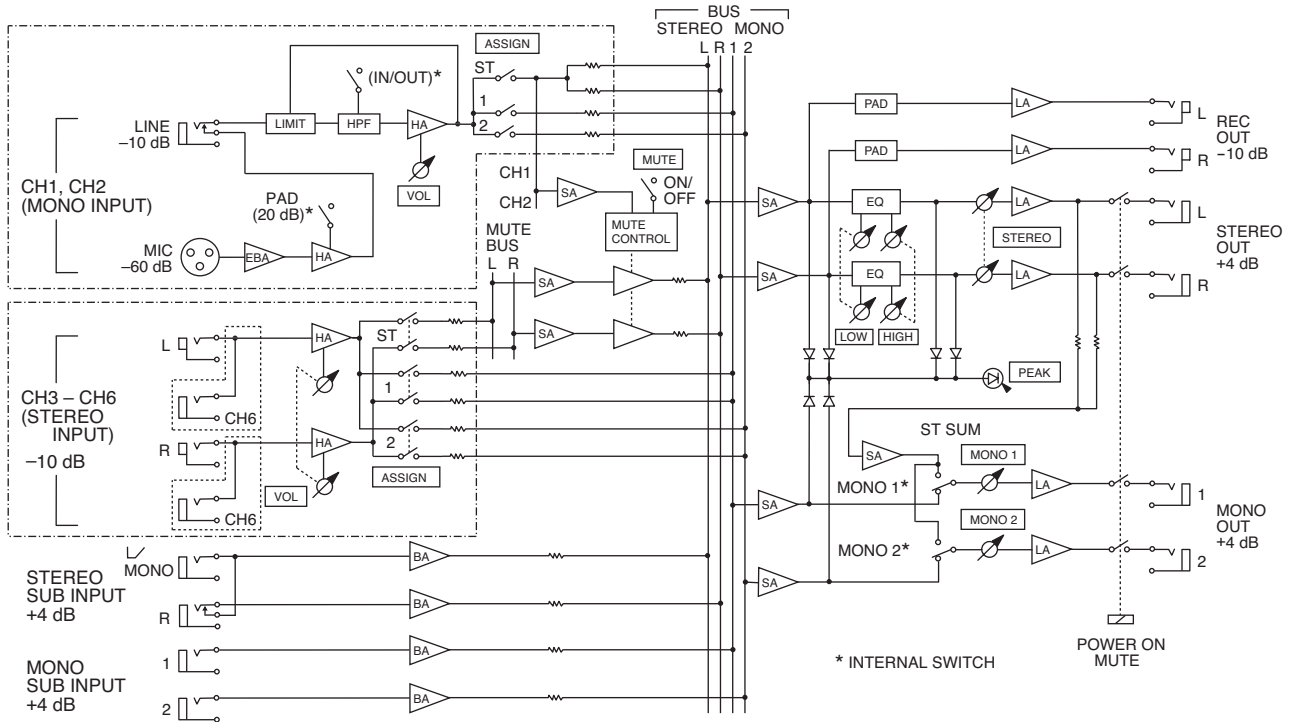

# 8. DIMENSIONAL DIAGRAM

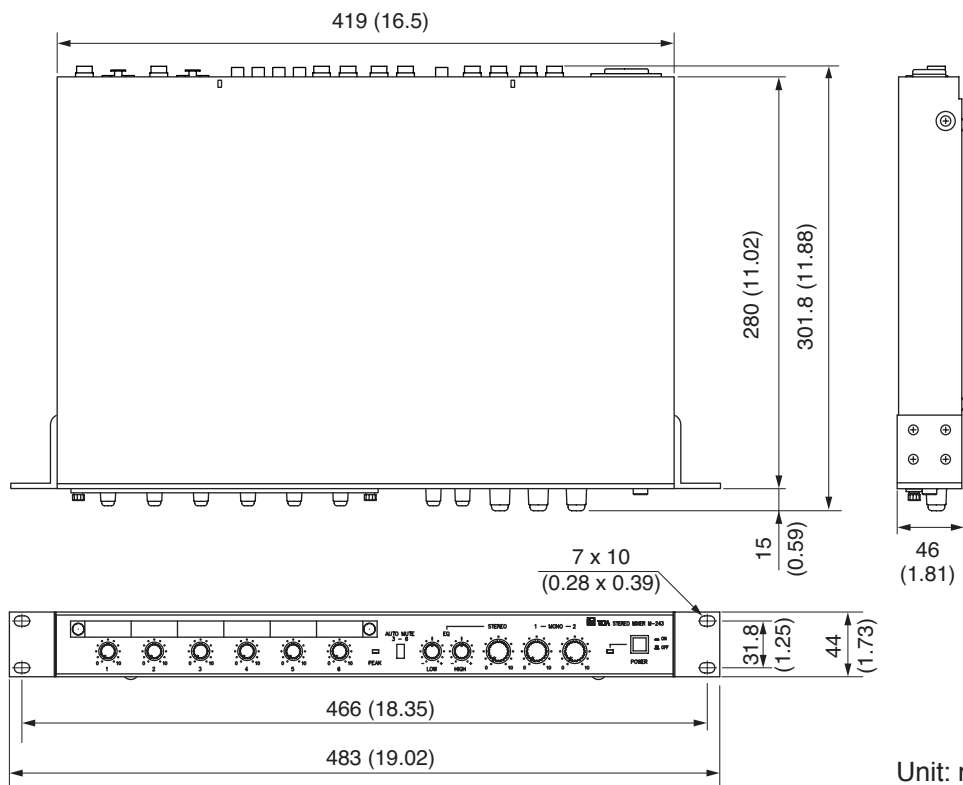

Unit: mm (in)

## 9. SPECIFICATIONS

Power Source	M-243 L: 120 V AC, 60 Hz M-243 301H: 220 – 240 V AC, 50/60 Hz
Power Consumption	M-243 L: 10 W M-243 301H: 12 W
Monaural Input	Line: –10 dB*, 10 kΩ, unbalanced, ϕ 6.3 mm phone jack (2 P) Mic: –60 dB*, 1 kΩ, balanced, 3-pin XLR connector Mic (Pad): –40 dB*, 1 kΩ, balanced, 3-pin XLR connector
Stereo Input (L, R)	–10 dB*, 10 kΩ, unbalanced, RCA jack
Auxiliary Stereo Input	+4 dB*, 50 kΩ, unbalanced, ϕ 6.3 mm phone jack (2 P)
Stereo Output (L, R)	+4 dB*, 1 kΩ, unbalanced, ϕ 6.3 mm phone jack (2 P)
Monaural Output	+4 dB*, 1 kΩ, unbalanced, ϕ 6.3 mm phone jack (2 P)
REC Output (L, R)	–10 dB*, 1 kΩ, unbalanced, RCA jack
Frequency Response	20 Hz – 20 kHz (+1, –2 dB)
T.H.D.	0.01 % or less (1 kHz, rated input/output)
Noise Level (IHF-A)	When all volume controls are in minimum position. Stereo output (L, R): –105 dB* or less Monaural Output (1, 2): –98 dB* or less When the stereo, monaural (1, 2) are in maximum position Stereo output (L, R): –94 dB* or less Monaural Output (1, 2): –95 dB* or less
Finish	Front Panel: Alumite, black Case: Steel, black
Dimensions	483 (w) x 46 (h) x 301.8 (d) mm (19.02" x 1.81" x 11.88")
Weight	3.8 kg (8.38 lb)

\* 0 dB = 0.775 Vrms

**Note:** The design and specifications are subject to change without notice for improvement.

### • Accessories

Power cord (2 m or 6.56 ft) .....	1
Rack mounting screw (5 x 20) .....	4
Rubber foot .....	4
Knob (blue, small) .....	2
Knob (red, small) .....	2
Knob (blue, large) .....	1
Knob (red, large) .....	1

### Traceability Information for Europe

Manufacturer:  
TOA Corporation  
7-2-1, Minatojima-Nakamachi, Chuo-ku, Kobe, Hyogo,  
Japan

Authorized representative:  
TOA Electronics Europe GmbH  
Suederstrasse 282, 20537 Hamburg,  
Germany